

QUANTUM DI WATER HEATER

Operation / Maintenance Manual

SERIAL NUMBER:

PATENTS: U.S. 5971402, U.S. 6433319, U.S. 6479094B2, U.S. 6544583B2,
U.S. 6580061B2, U.S. 6663914, U.S. 6674053B2;
ADDITIONAL PATENTS PENDING

CONTENTS

| | | |
|-------|--|----|
| 1 | INTRODUCTION | 3 |
| 2 | SAFETY | 6 |
| 2.1 | SAFETY MESSAGE CONVENTIONS | 6 |
| 2.1.a | Danger | 6 |
| 2.1.b | Warning | 6 |
| 2.1.c | Caution | 7 |
| 2.2 | EQUIPMENT SAFETY | 7 |
| 2.3 | EMERGENCY OFF (EMO) | 7 |
| 2.4 | PROCESS INTERLOCKS | 8 |
| 2.4.a | Low Pressure Switch Interlock | 8 |
| 2.4.b | Liquid Level Sensor Interlock | 9 |
| 2.4.c | Element Over Temperature Protection | 9 |
| 2.4.d | Leak Sensor | 9 |
| 2.4.e | Overpressure Burst Fitting | 9 |
| 2.5 | LOCKOUT / TAGOUT | 9 |
| 2.5.a | Preliminary | 9 |
| 2.5.b | Definitions | 10 |
| 2.5.c | Machine Shutdown with door closed | 11 |
| 2.5.d | Machine Start-Up with door closed | 11 |
| 2.5.e | Machine Shutdown with door open | 11 |
| 2.5.f | Machine Start-Up with door open | 12 |
| 2.6 | SEISMIC PROTECTION | 12 |
| 3 | INSTALLATION | 13 |
| 3.1 | UNPACKING | 13 |
| 3.2 | LOCATION | 13 |
| 3.3 | HOOK-UP | 13 |
| 3.3.a | Ethernet Communication | 15 |
| 3.3.b | Changing Heater IP Address | 16 |
| 4 | OPERATION | 17 |
| 4.1 | GENERAL | 17 |
| 4.2 | DIAGNOSTIC DISPLAY | 17 |
| 4.2.a | Main Page | 17 |
| 4.2.b | Alarm Status Page | 18 |
| 4.2.c | Module Status Page | 20 |
| 4.2.d | Process Plot Page | 20 |
| 4.2.e | Configuration Page | 21 |
| 4.2.f | Log Reports | 23 |
| 4.2.g | Security Status Page | 26 |
| 4.3 | REMOTE OPERATION OVER A NETWORK | 28 |
| 4.3.a | Ethernet Interface | 28 |
| 4.3.b | Modbus Protocols | 28 |
| 4.3.c | Modbus/TCP | 29 |
| 4.3.d | Modbus Communication | 29 |
| 5 | START-UP | 31 |
| 5.1 | PRE-START INSPECTION | 31 |
| 5.1.a | Verify Shipping Condition | 31 |
| 5.1.b | Hazardous Power Terminals | 31 |
| 5.1.c | Electrical Inspection | 31 |
| 5.1.d | Plumbing Leak Check | 31 |
| 5.2 | SYSTEM ON | 32 |
| 5.3 | HEATER MODULE POWER | 32 |
| 5.4 | PROCESS ALARMS | 32 |
| 6 | SHUT DOWN | 33 |
| 7 | MAINTENANCE | 34 |
| 7.1 | REPAIR INSTRUCTIONS | 34 |
| 7.1.a | Heater Element Check | 34 |
| 7.1.b | Heater Replacement | 34 |
| 7.1.c | Liquid Level and Leak Sensor Calibration | 36 |
| 7.1.d | Fuse Replacement | 36 |
| 7.1.e | Draining the System | 36 |
| 7.1.f | Leaks | 37 |
| 7.1.g | Overpressure Relief Replacement | 37 |
| 7.2 | PREVENTIVE MAINTENANCE SCHEDULE | 38 |
| 8 | TROUBLESHOOTING | 40 |
| 9 | WARRANTY | 41 |

See Appendix for specific system requirements.

1 INTRODUCTION

QUANTUM DI WATER HEATER

TREBOR's Quantum deionized water heater will meet your most stringent application requirements for process cleanliness and temperature control. Our unique heater design virtually eliminates the potential for metal contamination due to potentially exposed metal heating elements in immersion style heaters, while process control and reliability are designed to outperform and outlast other available quartz heating systems.

Trebor's DI water heater uses a revolutionary heating technology to provide exceptional process purity and control. Heat is generated using resistive heating elements conducted to the fluid through quartz tubes using convective heat transfer. This conductive / convective heating method allows the heating element to operate at a much cooler temperature than IR heating systems and provides the basis for a responsive heating control system.

The Quantum heater modules have smooth surfaces with minimal cracks and crevices, reducing particle traps. Furthermore, no pipe threads or elastomeric O-rings are used. With the exception of the exposed tip of the titanium temperature sensor (included with the fast response option), the DI water is exposed only semiconductor grade quartz, PTFE, and PFA wetted surfaces.

Trebor's patented heating module technology is constructed to provide excellent process control by minimizing hold-up volume and thermal heat capacitance while maximizing the heat transfer. While heating, the system can ramp to a process temperature in a "no flow" condition. The ability to withstand these extreme transient conditions allows the heater to operate without the need of flow monitors or flow switches to protect the heaters. This also reduces the consumption of DI water by minimizing temperature transition time and bypass to drain requirements.

Many product safety features have been incorporated into the Quantum heater. Each system has a liquid level sensor, leak sensor, grounded heater modules, ground fault protection, and redundant control system interlocks. An electro-mechanical contactor disengages power to the heaters when a fault condition occurs.

This equipment is built and certified to semiconductor manufacturing industry requirements of SEMI S2-0703. Please contact Trebor regarding any questions.

Conformity of the equipment with the above guidelines is attested by the TUV certification mark.

This equipment complies with the requirements of the EU guidelines:



**Figure 1-1: 89/392/EEC “European Machinery Directive”
89/336/EEC “European EMC Directive”**

Conformity of the equipment with the above guidelines is attested by the CE mark.

This equipment also complies with the requirements of the “Management Methods for Controlling Pollution of Electronics Information Products”, known as “China RoHS”.



Figure 1-2: China RoHS - Electronic information product pollution control symbol

Trebor will use an EFUP (Environmental Friendly Use Period) of 25 years, which is consistent with the industry mean. The EFUP label is located next to the main system nameplate and a declaration table is included below.

Table [表]

| Part Name [部件名称] | Table of Hazardous Substances and Elements [产品中有毒有害物质或元素的名称及含量] | | | | | |
|---------------------|--|------------------------|------------------------|--|---|---|
| | Lead [铅] (Pb) | Mercury [汞] (Hg) | Cadmium [镉] (Cd) | Hexavalent Chromium [六价铬] (Cr (VI)) | Polybrominated biphenyl [多溴联苯] (PBB) | Polybrominated diphenyl ether [多溴二苯醚] (PBDE) |
| QA1V208P12-AA | X | | | | | |
| QA1V380P10-AB | X | | | | | |
| QA1V415P10-AB | X | | | | | |
| QA1V480P10-AD | X | | | | | |
| QA1V480P12-AB | X | | | | | |
| | | | | | | |

O = This substance is present at a concentration below the limit in SJ/T 11363-2006 in **all** of the homogeneous materials for this part, and it has not been intentionally added to any metallic coating. (See SJ/T 11363-2006 for definition of homogeneous materials)
X = This substance is present at a concentration above the limit in SJ/T 11363-2006, in **at least one** of the homogenous materials for this part, or it has been intentionally added to a metallic coating. (See SJ/T 11363-2006 for definition of homogeneous materials)
 Notes: concentration limits of 1000 ppm (0.1% by weight) for lead, mercury, hexavalent chromium, polybrominated biphenyls (PBB) and polybrominated diphenyls ether (PBDE), or 100 ppm (0.01% by weight) for cadmium.
 Please refer to AeA's website for an English translation of SJ/T 11363-2006 (or the latest revision of this document):
http://www.aeanet.org/governmentaffairs/gajl_MCV_SJT11363_2006ENG.asp

2 SAFETY

This section describes information that is important for safe equipment operation. Included is a listing of message conventions used in this manual, as well as equipment safety interlocks, push buttons, and labels.

The equipment described in this manual uses hazardous voltage electricity that can be dangerous. Only personnel trained in the procedures and safety messages outlined in this manual should install (if applicable), operate, or maintain this equipment. Read and understand this manual before installation or operation of the system. Follow all recommended practices and procedures that apply to your actions and conduct. All safeguard devices must be in place when equipment is in operation. Operators, set-up operators, helpers or installation personnel should not alter, remove or disable safety equipment. When using this equipment, be sure to follow the safety procedures outlined by your facility. These safety procedures should cover the two primary types of hazard training: (1) equipment hazards and (2) facility-related hazards.

2.1 SAFETY MESSAGE CONVENTIONS

Safety messages contained in this manual; **Dangers, Warnings, and Cautions**, are highlighted for quick identification.

2.1.a Danger

A Danger message indicates an imminently hazardous situation that, if not avoided, will result in death or serious injury. Messages identified by the word **Danger** are used sparingly and only for those situations presenting the most serious hazards.

2.1.b Warning

A Warning message indicates a potentially hazardous situation that, if not avoided, could result in serious injury. Following is a typical example of a **Warning** message as it could appear:



2.1.c Caution

A Caution message indicates a potentially hazardous situation, which, if not avoided, could result in minor or moderate injury. It may also be used to alert against unsafe practices. Following is a typical example of a **Caution** message as it could appear:



2.2 EQUIPMENT SAFETY

The rest of this section describes equipment safety features:

- Emergency Off Push button (EMO)
- Process Interlocks
- Main Power Disconnect Switch
- Lockout/Tagout Information
- Equipment Safety Labels

2.3 EMERGENCY OFF (EMO)

The EMERGENCY OFF button (EMO) is located on the front of the door. When the EMO circuit is activated by pushing the button in, the equipment will be placed into a safe shutdown condition. The EMO will de-energize the heaters and process interlock devices. Other devices on the panel remain energized and hazardous voltages will be present on the power supply and power supply fuses, sub panel circuit breakers and contactors. Use the Main Power Disconnect Switch to remove power from the panel.

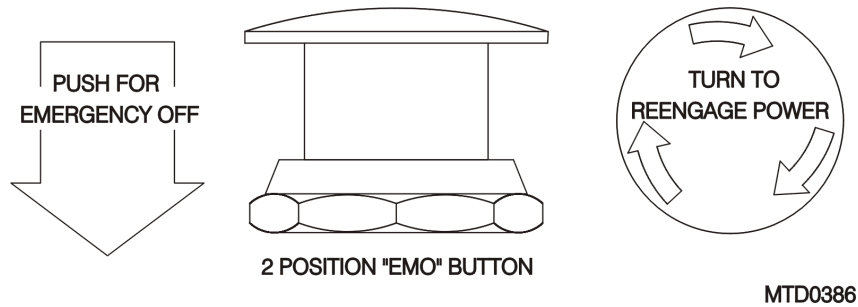

Figure 2-1

On power up or after the EMO has been pushed, the heater must be reset by pressing the blue RESET button to reactivate the controls. This must be done at the machine.

2.4 PROCESS INTERLOCKS

The process fault interlocks are latched into the logic controller (PLC) memory. When a fault occurs, the user interface will display the alarm condition and the horn will sound. Pressing the RESET button will silence the audible horn. The system will retain the fault until it is cleared. Pressing the RESET button may restart the heater. If the indicator LED's remain illuminated then one or more faults are still active. Refer to Section 8, Troubleshooting.



CAUTION: The interlock circuit does not remove hazardous voltage from the circuit breakers, contactor, and the control transformer. Only authorized, qualified, trained personnel should service this equipment.

2.4.a Low Pressure Switch Interlock

The pressure switch will disengage power if system inlet water pressure drops below 15 psig (103 kPa). The heater will come back online if the pressure recovers within a 30 second time period. This prevents nuisance trips due to transient conditions in the DI water supply while still protecting the heater. However, erratic process temperature control may result if heater power is disengaged during the pressure transient.

2.4.b Liquid Level Sensor Interlock

The Liquid Level Sensors will disengage power to the system if the heater modules are not full of water or if boiling in the heating module occurs. The heater will reengage if fluid is present within a 30 second time period. This prevents nuisance trips due to transient conditions in the DI water supply while still protecting the heater during startup. It is critical that these sensors operate properly. Do not tamper with the sensors. Damage to the system can result if the sensors are altered or overridden.

NOTE: On the dual output option, this interlock will protect the heaters it monitors (i.e. sensor 1 will protect the modules supplying output 1).

2.4.c Element Over Temperature Protection

The temperature limit controller monitors a thermocouple attached to the heater element. In the event that the element temperature exceeds the normal operating temperature, the system will immediately disengage power and alarm. If this occurs, check element continuity before continuing normal operation. See Section 7.1.a.

2.4.d Leak Sensor

The Leak Sensor will disable heater power immediately when water is detected in the leak tray. Fix any leaks and dry the leak sensor and leak tray prior to turning power on to the system.

2.4.e Overpressure Burst Fitting

The overpressure burst fitting (“Relief Drain”) is connected in-line with the cold DI inlet port to provide a mechanical safeguard against possible overpressure damage. Do not operate the heater above 414 kPa (60 psig).

If the overpressure relief device opens, the low-pressure sensor will alarm. A periodic visual inspection of the fitting is recommended. Refer to Section 7.1.g on replacing burst fitting.

2.5 LOCKOUT / TAGOUT

2.5.a Preliminary

Before installation or servicing the DI water heater, the facility’s power source to the heater must be de-energized to prevent serious injury to personnel and equipment. An authorized employee representing the facility installing the DI water heater must follow approved company guidelines and lockout or use suitable means to prevent re-energizing the electrical system during installation or servicing.

2.5.b Definitions

Lockout: the placement of a lockout device on an energy isolating device, in accordance with established company procedures, ensures that the energy isolating device and the equipment being controlled cannot be operated until the lockout device is removed.

Tagout: a prominent warning device such as a tag and a means of attachment, which can be securely fastened to an energy isolating device in accordance with established company procedure, ensures that the energy isolated device and the equipment being controlled may not be re-energized or operated until the tagout device is removed.

This table lists the Lockout/Tagout information for the system.

| | |
|--|---|
| Energy Type | Electrical |
| Hazard: | Electrocution, electrical burns, and shock |
| Magnitude: | 480 VAC or 415 VAC or 380 VAC or 208 VAC See system label for exact voltage. |
| Control Method: | Main Power |
| Shutdown Procedure | |
| Switch off circuit breaker on front of system. | |



Figure 2-2: Lockout/Tagout

2.5.c Machine Shutdown with door closed

Perform the following sequence of events in the order listed for electrical energy isolation of the tool:

1. Notify personnel in the area that you are going to shut down the equipment.
2. Shutdown the system in an orderly fashion.
3. Locate the main incoming power disconnect switch-actuating handle.
4. Move the actuating handle to the "OFF" (down) position.
5. Apply the locking energy isolation device (lock) through the hole in the actuating handle and secure the lock.
6. Verify that the tool has been isolated and de-energized by attempting to turn the main power disconnect back to the "ON" position and/or by pressing the machine start button. The machine power must not be reapplied and/or the machine must not start.

2.5.d Machine Start-Up with door closed

Perform the following sequence of events in the order listed for electrical re-energization of the tool:

1. Ensure that all hand tools are removed from the equipment and that it is ready for start-up.
2. Notify personnel in the area that you are going to start-up the equipment.
3. Open the lock and remove the locking energy isolation device (lock) from the hole in the actuating handle of the Main Disconnect Switch.
4. Move the actuating handle to the "ON" (up) position.
5. Press the machine start button. The machine should start.

2.5.e Machine Shutdown with door open

Perform the following sequence of events in the order listed for electrical energy isolation of the tool:

1. Notify personnel in the area that you are going to shut down the equipment.
2. Shutdown the system in an orderly fashion.
3. Locate the main incoming power disconnect switch-actuating handle.
4. Rotate the rotary disconnect shaft to the "OFF" or "0" (down) position.
5. Insert and rotate the key in the rotary disconnect lock (top left of rotary disconnect device). Remove the key.
6. Verify that the Tool has been isolated and de-energized by attempting to turn the rotary disconnect shaft back to the "ON" or "1" position and/or by pressing the machine start button. The machine power must not be reapplied and/or the Machine must not start.

2.5.f Machine Start-Up with door open

Perform the following sequence of events in the order listed for electrical re-energization of the tool:

1. Ensure that all hand tools are removed from the equipment and that it is ready for start-up.
2. Notify personnel in the area that you are going to start-up the equipment.
3. Insert and rotate the key in the rotary disconnect lock (top left of rotary disconnect device). Remove the key.
4. Move the rotary disconnect shaft to the "ON" of "1" (up) position.
5. Press the machine start button. The machine should start.

2.6 SEISMIC PROTECTION

It is the user's responsibility to adequately secure and anchor the equipment to comply with local regulatory agency seismic requirements. Mechanical anchors are provided using seismic brackets attached to the bottom of the cabinet enclosure. See Facility Layout in Appendix for bracket location.

3 INSTALLATION

3.1 UNPACKING

Remove heater system from crate and inspect heater cabinet for any signs of damage (dented panels, paint scratches, etc.). Shock indicators on the heater cabinet should be checked for rough handling during shipment. Any damage to the system should be reported to the carrier immediately.

Front door keys are not shipped with the system. Keys are available upon request. (Key, Handle, 'L' LOC, [PROLINE] #98003360/B).



CAUTION: Heavy Object. When lifting or moving the system, follow safe heavy object handling methods to prevent injury.

Be careful to not damage the drain fitting located under the heater cabinet when using a dolly or forklift.

3.2 LOCATION

Locate the heater near the point-of-use to reduce plumbing heat loss. Access to the front and rear of the system will be necessary for maintenance and hook-up.

3.3 HOOK-UP

All utility hook-ups associated with the DI water heater are easily accessible and are referenced in the Appendix.

After positioning heater at operating location, adjust the four leveling feet until the heater is level and stable.

- Connect the cold DI supply line to the “Cold DI Inlet” connection.
- Connect the hot DI process lines to the “Hot DI Outlet” connection. Use only hot DI compatible plumbing components. They must be rated at a minimum of 110°C (230°F) and 414kPa (60 psig).

NOTE: It is recommended that the hot water supply line have a bleed, or purge, at the point-of-use to reduce the possibility of the DI water becoming stagnated in the heaters when not in use. The amount of this bleed is best evaluated on a case-by-case basis, taking into account each user’s criteria and production standards.

- Recommendation: Either insulate the hot DI water process line or place a Hot Surface hazard warning (example shown below) on the tubing every 20 feet. Conform to local codes while evaluating hot water line routing.



- Connect the “Over Pressure Relief Drain” to an open drain line with no more than 30’ of ¾” tubing. Do not connect restrictive fittings or valves in line with the drain. If an overpressure condition occurs in the heater, a burst fitting will relieve pressure in the heater. The fitting must be replaced (see Section 7.1.g).
- Attach cabinet drain line to bottom of cabinet. If a cabinet drain line is not installed, the system will be difficult to drain should repairs be needed.

 **CAUTION:** Depending on installation and routing of water supply lines, a trip hazard may be created. It is the responsibility of the facility installation personnel to eliminate or minimize any and all trip hazards or identify such hazards with visual warning signs.

- **Lockout** and **Tagout** facility power connection switch or equivalent before installing system.
- Open the front door by rotating the electrical disconnect handle to the OFF position and then rotate the door handle. This will allow access to the electrical connections.
- Route the wires from the electrical source (480 VAC, 415VAC, 380 VAC, or 208 VAC 3-phase) into and through the conduit opening on the top of the enclosure. To secure an electrical conduit fitting, remove lifting eyebolts located on top of the system and raise the vented top panel. The conduit nut may then be secured. Reassemble the vented top panel to the enclosure.

- Connect the supply grounding wire to the grounding lug and the other three lines into the top of the circuit breaker connections (L1, L2, and L3) as shown in Figure 3-1 (torque wire terminal connections to 120 in/lb).

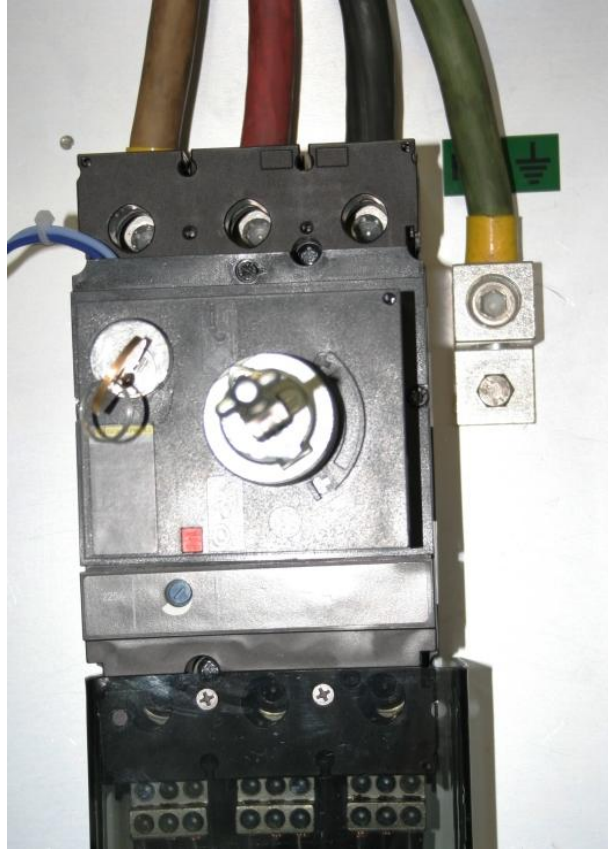

Figure 3-1:

- Close the door and secure.
- Check ground continuity on cabinet to any facility ground.
- Remove Facility power Lockout/Tagout.
- Restore Facility power supply to the heater.
- Follow heater Pre-Start Inspection (see Section 5.1).

NOTE: Before starting the system, it is important to become familiar with Section 4, Operation. Only trained, qualified, authorized, personnel should operate this system.

3.3.a Ethernet Communication

For remote monitoring and control of the heater, plug an Ethernet cable into the RJ45 connector on the lower rear connection panel of the system.

3.3.b Changing Heater IP Address

ATTENTION: This section of the manual assumes you know the basics behind IP addressing. If you are unfamiliar with IP addressing, do not attempt to change the IP address of the heater. Incorrect assignment of an IP address could leave the Ethernet functionality of the heater unusable by your current network configuration.

The heater ships with an IP address already assigned to it. The current IP address of the heater can be viewed and changed from the heater touch screen.

To view the current IP address and subnet mask of the heater, go to the configuration screen in the touch screen. The IP address and subnet mask are shown in the center of the screen.

To change the IP address of the heater, press the “IP Addr” button on the right hand side of the configuration screen (see Section 4.2.e). A window will open that will allow you to change the IP address and subnet mask of the heater. Pressing the “Enter” button assigns the new IP address to the heater. If you wish to cancel the changes made press the “X” button at the top right of the window.

Please note that the new IP address is assigned as soon as the “Enter” button is pressed. The previous IP address will also remain active until power to the heater is cycled.

NOTE: Changing the IP settings may cause a WIN CE warning message to appear. This warning is non-critical, and the heater will continue to operate normally. To eliminate this warning message, do not hit “OK” or “Cancel”. Instead, simply tap anywhere in the touch screen, outside of the warning message.

4 OPERATION

4.1 GENERAL

The Quantum is very easy to operate. Once DI water is flowing through the system and power is turned on, a process temperature can be selected and power switched on to the heater modules. The controls will do the rest.

If there is a problem with the DI water heater, the system controller will notify the operator that the heater requires attention. After the fault condition is corrected, the heater can be reset using the RESET button located on the heater door (the fault condition will also be cleared if the entire system power is cycled off and on). Redundant hardware relay interlocks back up heater element temperature, leak sensor, and component temperature faults.

4.2 DIAGNOSTIC DISPLAY

A color touch screen provides an intuitive interface to the DI water heater. The heater can also be operated using both hardware and software remote interfaces (depending on the heater options). The display is divided into several pages. The pages are designed to be simple and easy to understand. The display contains a total of six pages.

4.2.a Main Page

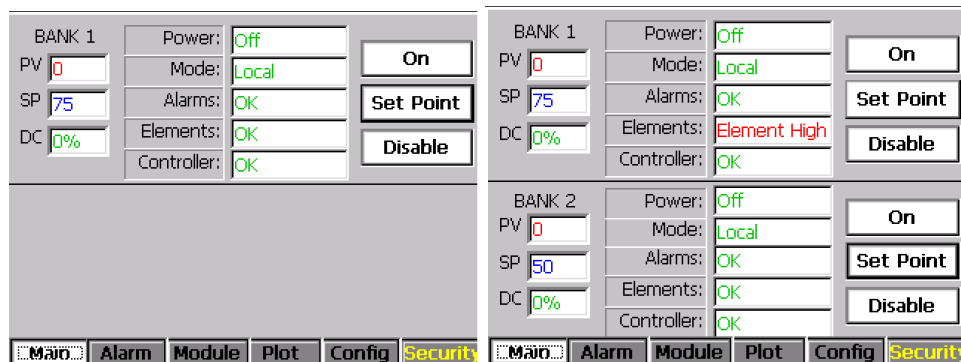

Figure 4-1: Main Screen (single & dual bank version shown)

The main page is the first page that is displayed after the heater is powered on. This page is designed to show you the current status of the heater at a glance. The set point, process value, duty cycle, alarm conditions, heater module errors, and internal communication status are displayed.

This page also contains a button to turn the heater on and off, a button to change the set point and enable and disable of the heater.

An enable button is provided that, when activated, will open the inlet valve and allows the heater bank to be turned on. This function is active in single and multiple output systems. This feature provides the ability to safely disable a bank of heaters in a multiple outlet system.

After enabling the heater and when in local control mode, the on/off button can be used to turn the heater on or off.

The temperature set point can be changed by pressing the “SP” button or by pressing the current set point value on the left hand side of the screen. The set point value can be changed on any page by pressing the set point value on the left hand side of the screen.

The buttons on the bottom of the page will take you to the other pages.

4.2.b Alarm Status Page

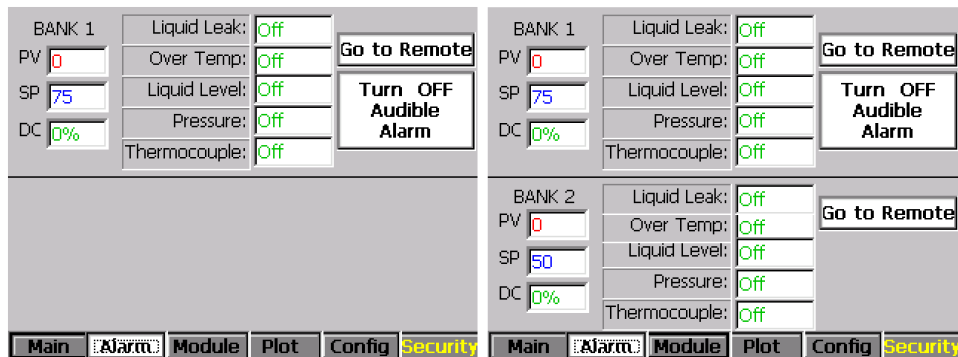

Figure 4-2: Alarm Status Page (single & dual bank version shown)

The alarm page shows the alarm status of the heater, enables the user to change the mode of the heater and allows the option of turning the audible alarm (horn) off from the panel.

The mode of the heater can be toggled from “Local” mode to “Remote” mode by pressing the button on the right hand side of the screen. The button text changes from “Go to Local” to “Go to Remote” depending on the current mode of the heater. Local mode allows the heater to be turned on and off from the touch screen and disables turning the heater on and off remotely. Remote mode allows the heater to be turned on and off remotely using a software or hardware remote interface to the heater (depending on the heater options) and disables turning the heater on and off from the touch screen. The mode of the heater can only be changed from the touch screen. Note that the mode status is also displayed on the main page.

All of the heater alarms are listed on this page. When the heater system enters an alarm state the heater is turned off and a horn sounds. This horn can be turned off by pressing the reset button or by pressing the turning off audible alarm off button on the alarm page.

| Alarm Name | Function |
|-------------------------|---|
| Pressure Alarm | Insufficient inlet water supply pressure |
| Liquid Level Alarm | Insufficient fluid level |
| Thermocouple Open Alarm | Broken/Disconnected Thermocouple lead |
| Liquid Leak Alarm | Fluid Leak Detected – water in base area or fluid on back side of burst device (for optionally installed burst device rupture sensor) |
| Over Temperature Alarm | One or more elements have exceeded the protective temperature limit |

Alarms can have the following states:

- Alarm Ok – all alarms are off.
- Alarm Delay – pressure and liquid level alarms have a timeout period. These alarms will wait a certain period of time before putting the system into an alarm state. During the timeout period the heater is put in a safe state while waiting for these alarms to clear themselves and the alarm will be in the alarm delay state. If these alarms clear themselves before the timeout period elapses, the heater will go back to normal operation without alarming. If these alarms do not clear themselves before the timeout period expires, the heater will alarm. The time delay for these alarms is set on the system configuration page.
- Alarm Active – any alarm that has not been cleared and is still active is in this state.
- Alarm On – any alarm that has not been cleared but is no longer active is in this state.

The buttons on the bottom of the page will take you to the other pages.

4.2.c Module Status Page

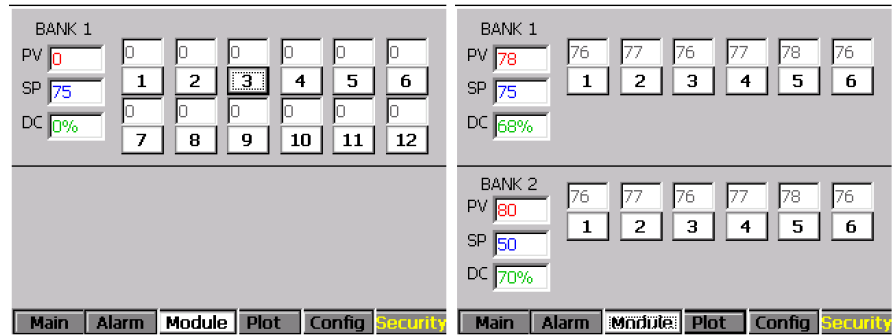

Figure 4-3: Module Status Page (single & dual bank version shown)

The module status page shows the temperatures of each of the heater modules.

If the heater module temperature is shown in black lettering with a white background, the module is functioning properly. If a heater module temperature is displayed with blue lettering, the heater is running too cool compared to the other heaters in the bank. If a heater module temperature is displayed with red lettering, the heater is running too hot. Heaters running too hot or too cold should be checked as soon as possible. See Section 7.1.a.

The numbered buttons below each temperature status box correspond to the heater modules. These buttons enable or disable each module's thermocouple. When enabled, the thermocouple is considered in the temperature control algorithm and is monitored for the Thermocouple Open Alarm condition (see Section 4.2.b).

The buttons on the bottom of the page will take you to the other pages.

4.2.d Process Plot Page

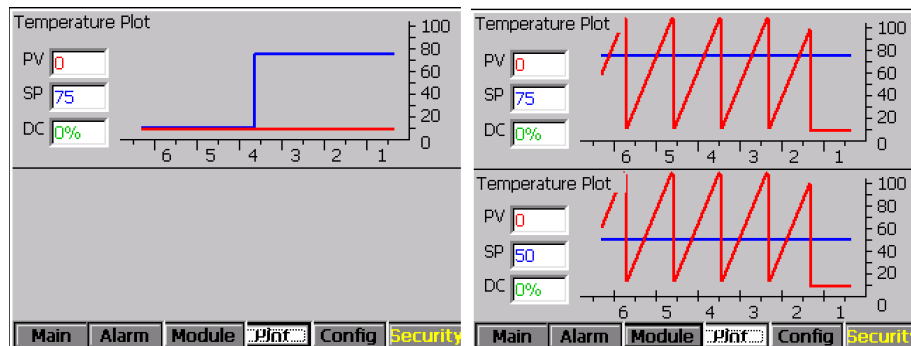

Figure 4-4: Plot Page (single & dual bank version shown)

The process plot page shows a plot of the set point and process value. The set point is displayed with a blue line and the process value is displayed with a red line. The plot is refreshed approximately every two seconds.

The buttons on the bottom of the page will take you to the other pages.

4.2.e Configuration Page

| SYSTEM CONFIGURATION | | Alarm Delay |
|----------------------|------------------|-------------|
| Alarm Delay | 30 | IP Address |
| IP Address | 10.48.64.204 | Serial Comm |
| Sub Net Mask | 255.255.248.0 | Time/Date |
| Banks | 2 | Language |
| Modules | 6 | View Logs |
| Heater kW | 60 | Sys. Setup |
| Voltage | 480 | |
| Serial Number | QTM60123 | |
| Controller Rev | 2.0.34 | |
| Display Rev | C.1.00.18-V2.0.1 | |

Main Alarm Module Plot **Config** Security

Figure 4-5: Configuration Page

The configuration page shows a summary of system information, and allows changes to the heater IP Address, Serial Communications Settings, Alarm Delay, and System Time and Date. This page also allows access to log files described in Section 4.2.f.

Press the “Alarm Delay” button to set the pressure and liquid level alarm delay. Enter the desired alarm delay in seconds and press enter.

Press the “IP Address” button to set the current IP address and subnet mask of the heater. See Section 3.3.b for details.

Figure 11: IP Address Change

The current IP address and mask is displayed. Note that the field being edited is displayed in red. Press the “Enter” button when done changing the IP address or mask to apply the changes. Changes to the IP address and mask will take effect immediately. Please note that the previous IP address and mask will remain active in the system until power is cycled to the heater.

Press the “Serial Comm” button to change serial communications settings. Default settings are 9600, 8, E, 1.



Figure 12: Serial Communication Setup

Press the “Time/Date” to set the system time and date.

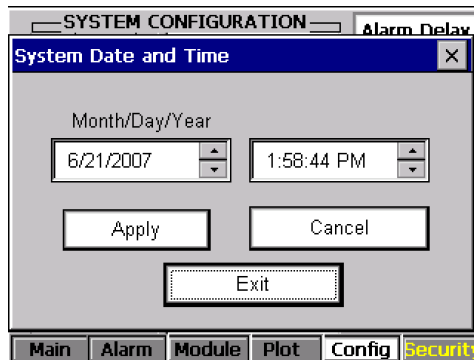

Figure 13: Changing System Date and Time

When changing the system date or the time, each field must be changed and apply button pressed to update the system before changing the next field. For instance, if the month and day fields need to be changed, select the month field. Use the up and down arrows to select the correct month. When done, press the “Apply” button before selecting the day field. Use the up and down arrows to select the correct day and press the “Apply” button to initiate that change. This also applies to the time. The hour, minute and AM/PM field must be changed separately by changing the field and pressing the “Apply” button to apply that change.

Press the “View Logs” button to access the log reports described in section 4.2.f.

A “Config” button is present on the Config page for select heater configurations. This button allows the setup of configuration-specific settings.

The buttons on the bottom of the page will take you to the other pages.

4.2.f Log Reports

Log reports are generated to capture three types of data: *Alarms, Events, and System.*

The Alarms log captures Pressure, Liquid Level, Thermocouple Open, Liquid Leak, and Over Temperature alarms (see section 4.2.b for further explanation of alarms & alarm states).

The Events log will record “Events” that occur such as, Remote On or Off, Heater Banks running too hot or too cold, Banks being turned On or Off, etc.

The Systems log records such things as Emergency Shut Off activated, Reset Button depressed, changes to alarm settings, and several other settings that affect “system” changes.

Log files can be viewed through the heater touch screen interface, or on a remote PC via a web browser or a text editing program such as *MS Word* or *Notepad*:

To view the log files through the heater touch screen interface, press the “View Logs” button on the Config page (see section 4.2.e). First select the type of log file to view and click the “Open Log” button. Note that Alarms and Events log files will be available only after an Alarm and Event occurrence, respectively.

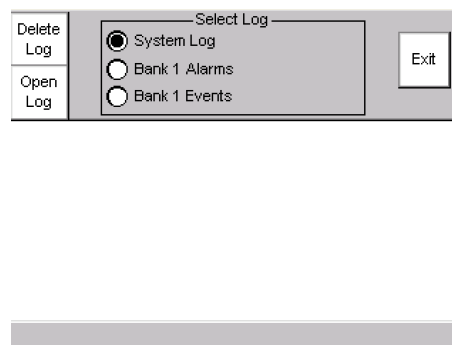

Figure 4-6: Select the Log to view

Select the desired log and press the Open Log button.

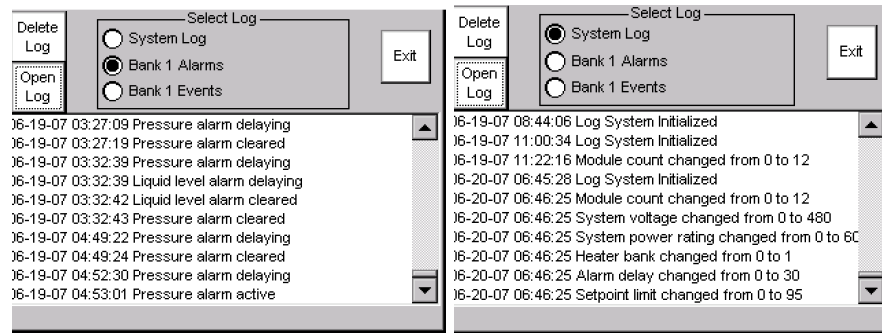

Figure 4-7: Example of System and Alarm logs

Log reports are time stamped. System time and date settings should be updated after initial startup to ensure accurate log information (see section 4.2.e). The most recent logged event is always listed at the end of the listing and the oldest at the beginning of the log.

Because of memory limitations, the log reports hold a finite number of records. When the report reaches a set size, the oldest record will be deleted each time a new record is added.

Select the “Exit” button when finished viewing.

Any of the log files can have its contents deleted by pressing the “Delete Log” button. A deleted log will be re-started when new records are generated.

To view the log files on a remote PC, the PC must be connected to the heater via the Ethernet connection on back side of the Quantum heater. The log files can be accessed through a web browser, by browsing to the heater IP address (see section 3.3.b for information on setting and observing the heater IP address). For example, if the heater IP address is set to “172.16.17.8” in the heater configuration page, then it should be entered into the address field of the web browser along with the storage card name. For example “172.16.17.8/storage card” would be entered without the double quotes. Note that the IP address on the remote PC must be in the same range as the heater IP address, and the appropriate Subnet Mask must also be the same on the remote PC. See local computer administrator for assistance.

After connecting the following interface will appear:

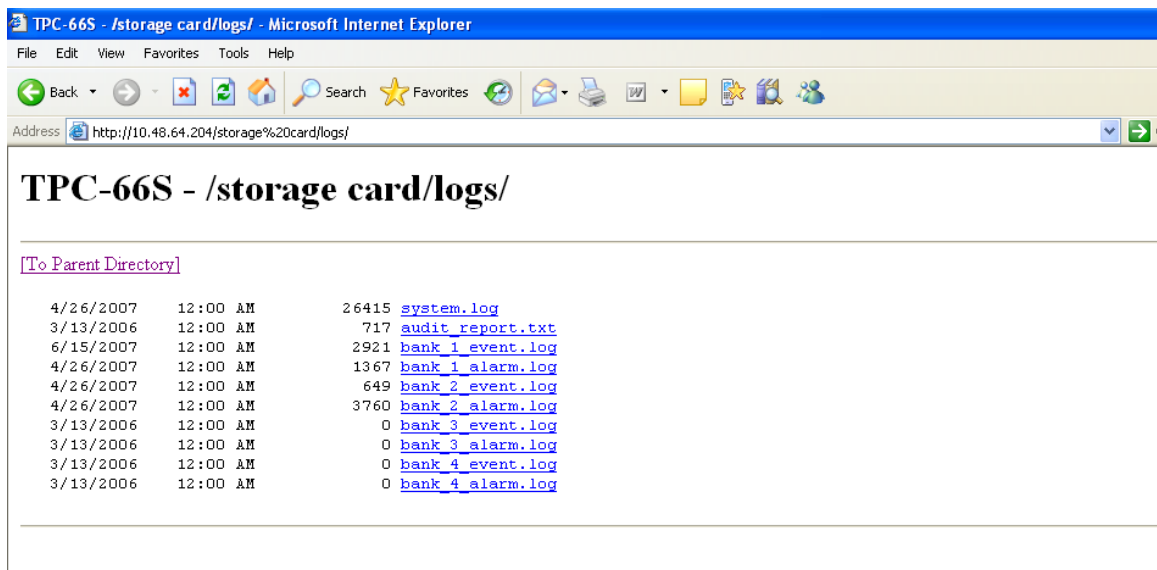
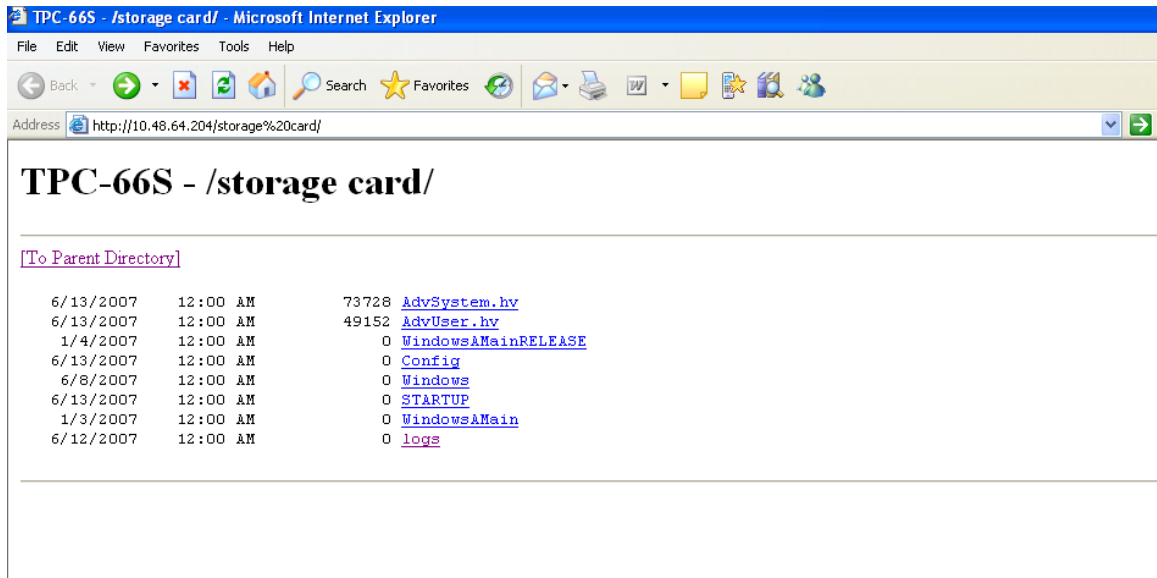

Figure 4-8: Ethernet Loaded Log Menu

To view the log files in the web browser, double-click the “LOGS” directory, and double click the desired log file. Click the browser’s “Refresh” button to update the latest changes to that log. The most recent logged event is always listed on the top of the listing.

To save the log files on the remote PC for viewing in a text editing program, double-click the “LOGS” directory and right-mouse-click on the desired log. Select “Save Target As” and specify the location and file name to be saved.

NOTE: For ease of viewing, the file extension should be changed from the default “.log” to “.txt”.

NOTE: Alarm and Events logs may appear for heater banks that are not available. Disregard these logs.

4.2.g Security Status Page

This heater is supplied with security features that will lock out the local user interface. When security is enabled, any screen can be viewed at any time but a four digit pass code is required to change the heater variables or states. When a valid pass code is entered in the security screen, it unlocks the system for a given time. Initially the time is set to 10 minutes but it can be changed from 01 minute to 99 minutes (must use two digits). The heater is shipped with this functionality set to the Disabled position.

- To enable the security features: Open the security page by selecting the Security button and enter the correct PIN, and check the Enable Security box. (Initial factory set PIN is “1234”)

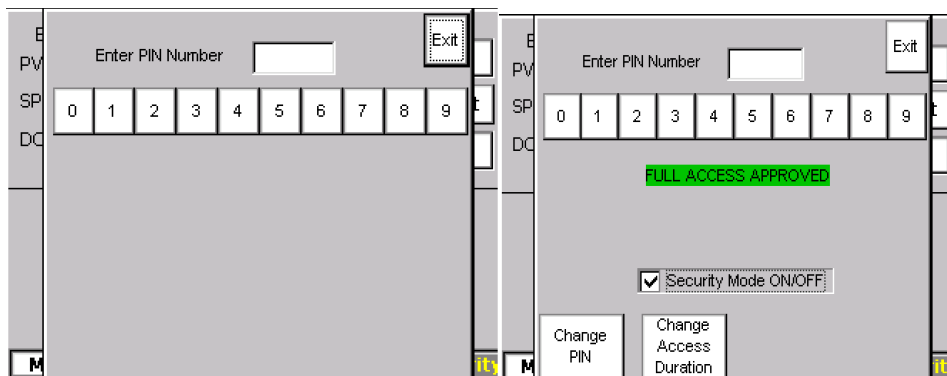

Figure 1: Security Status Page (before & after entering PIN)

- To disable the security features. Open the security page by selecting the Security page and enter the correct PIN, and uncheck the Security Mode box.

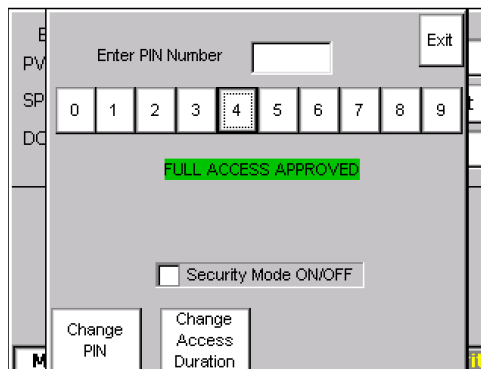

Figure 2: Security Status Page with Security Mode off

- To change your PIN number: Open the security page, enter the correct PIN, and press “Change PIN” button then enter a new four digit PIN code.

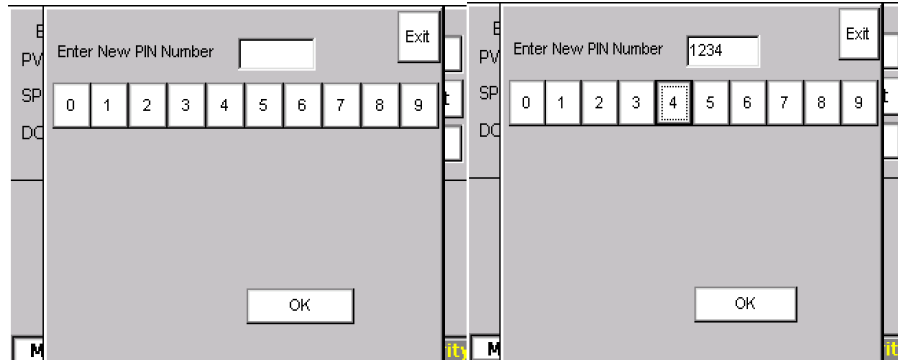

Figure 4-9: Entering new PIN Number

- To change the access time, open the security tab, enter your correct PIN, and select the access duration time by selecting the current access duration value. Note that the access duration value does not appear until after the “Security Mode is Enabled” is checked. Enter the new 2 digit time in the keypad and press the Enter button. The minimum duration is 1 minute with a maximum duration of 99 minutes.

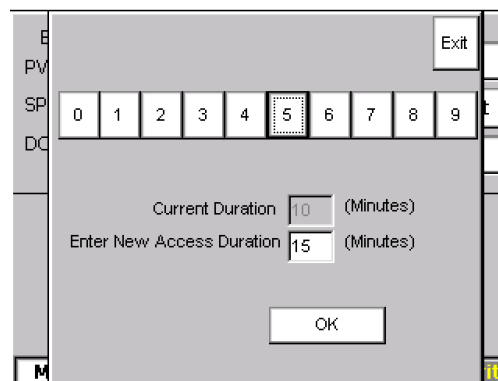

Figure 4-10: Changing the Access Duration

- Failure to provide a correct PIN will result in “Invalid Pin Number” message.

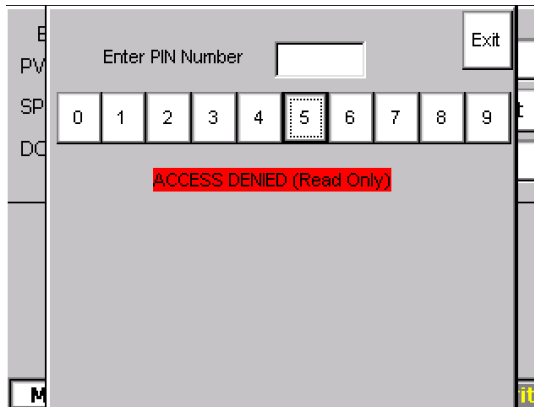

Figure 4-11: Invalid Pin

- If the user PIN number is lost: Contact Trebor for instructions to reset the security features.

4.3 REMOTE OPERATION OVER A NETWORK

4.3.a Ethernet Interface

The heater can be operated over an Ethernet network using either Modbus TCP or a proprietary software interface. A remote connection over Ethernet can turn the heater on and off, change the set point, and check the operation and the alarm status. Contact the factory for further information regarding the Ethernet software interface.

4.3.b Modbus Protocols

Quantum heaters can communicate on both Modbus/TCP and Modbus/RTU networks. Modbus/TCP communication is included in all Quantum heaters; Modbus/RTU communication is an option on all Quantum heaters. Using Modbus communication, Quantum heaters can be turned on and off remotely, the set point can be changed, and the operation status and alarms status can be monitored.

The Modbus register mapping for Quantum heaters is the same for both Modbus/TCP and Modbus/RTU protocols. The register mapping is for single, dual, triple and quadruple output Quantum heaters.

Table 1: Version 1 Modbus Mapping shows the new register mapping that uses only Modbus registers. Table 2: Version 2 Modbus Mapping shows the old register mapping that uses both Modbus registers and coils. While either mapping can be used, Trebor recommends that new installations use the new mapping in Table 1: Version 1 Modbus Mapping.

4.3.c Modbus/TCP

The heater can be operated over an Ethernet network using the Modbus/TCP protocol. Although the heater can be controlled directly using Modbus/TCP, Trebor recommends that the heater be controlled using a communication library written by Trebor. The Trebor communication library abstracts the details of Modbus/TCP. Currently, the library is available for Win32 platforms. If you need the library for another platform please contact the factory.

The IP address of the heater can be configured from the “Config” page on the heater touch screen (see Section 4.2.e).

4.3.d Modbus Communication

Table 1: Version 1 Modbus Mapping and Table 2: Version 2 Modbus Mapping includes register mappings for single, dual, triple and quadruple output Quantum heaters. For a standard single output Quantum heater use the “Bank 1” addresses. Table 1: Version 1 Modbus Mapping and Table 2: Version 2 Modbus Mapping contains the name, address, type, data type, size, and read/write permission for each register.

The Table 1: Version 1 Modbus Mapping interface to the Quantum heater is composed entirely of Modbus registers – no Modbus coils are used. This means that only two Modbus functions are required to communicate with a Quantum heater. The function 03 (read holding registers) and function 06 (write single register) are the only two Modbus functions that will be needed.

The Table 2: Version 2 Modbus Mapping interface is an old interface that uses both Modbus coils and registers. This interface is for backwards compatibility with the first generation of Quantum heaters. New installations should use the new register mapping found in Table 1: Version 1 Modbus Mapping.

To turn the heater on remotely, the value 1 must be written to the “Remote Heater Power” register. The heater must be in remote mode (see Section 4.2.b) to enable remote on/off of the heater. To turn the heater off remotely, the value 0 must be written to the “Remote Heater Power” register.

All of the Boolean data type registers are false when they contain the value 0 and true when they contain any value greater than 0. When writing to Boolean registers, false is represented by the value 0 and true is represented by the value 1.

The float data type registers need to be converted from network format to host format after being read. If you are using SCADA software this will be done automatically. If you are using the C or C++ programming languages this can be done using the C function ntohs().

For more information regarding Modbus communication please visit www.modbus.org.

| Name | Addr Bank 1 | Addr Bank 2 | Addr Bank 3 | Addr Bank 4 | Type | Data | Bytes | Perm |
|----------------------|-------------|-------------|-------------|-------------|------|-------|-------|------|
| Set Point | 16404 | 16529 | 16654 | 16779 | Reg | Short | 2 | RW |
| Process Temperature | 16405 | 16530 | 16655 | 16780 | Reg | Float | 4 | R |
| Duty Cycle | 16429 | 16554 | 16679 | 16804 | Reg | Float | 4 | R |
| Communication Status | 21384 | | | | Reg | Bool | 2 | R |
| Mode | 16389 | 16514 | 16639 | 16764 | Reg | Bool | 2 | R |
| Remote Heater Power | 16387 | 16512 | 16637 | 16762 | Reg | Bool | 2 | RW |
| Heater Power Status | 16384 | 16509 | 16634 | 16759 | Reg | Bool | 2 | R |
| Alarm Status | 16392 | 16517 | 16642 | 16767 | Reg | Bool | 2 | R |
| Alarm Liquid Level | 16394 | 16519 | 16644 | 16769 | Reg | Bool | 2 | R |
| Alarm Liquid Leak | 16396 | 16521 | 16646 | 16771 | Reg | Bool | 2 | R |
| Alarm Over Temp | 16397 | 16522 | 16647 | 16772 | Reg | Bool | 2 | R |
| Alarm Thermocouple | 16395 | 16520 | 16645 | 16770 | Reg | Bool | 2 | R |
| Alarm Pressure | 16393 | 16518 | 16643 | 16768 | Reg | Bool | 2 | R |

Table 1: Version 1 Modbus Mapping

| Name | Addr Bank 1 | Addr Bank 2 | Addr Bank 3 | Addr Bank 4 | Type | Data | Bytes | Perm |
|----------------------|-------------|-------------|-------------|-------------|------|-------|-------|------|
| Set Point | 1049 | 1149 | 1249 | 1349 | Reg | Short | 2 | RW |
| Process Temperature | 1051 | 1151 | 1251 | 1351 | Reg | Short | 2 | R |
| Duty Cycle | 1067 | 1167 | 1267 | 1367 | Reg | Short | 2 | R |
| Communication Status | 21384 | | | | Reg | Bool | 2 | R |
| Mode | 449 | 549 | 649 | 749 | Coil | Bool | 1 | R |
| Remote On | 453 | 553 | 653 | 753 | Coil | Bool | 1 | RW |
| Remote Off | 454 | 554 | 654 | 754 | Coil | Bool | 1 | RW |
| Heater Power Status | 452 | 552 | 652 | 752 | Coil | Bool | 1 | R |
| Alarm Status | 457 | 557 | 657 | 757 | Coil | Bool | 1 | R |
| Alarm Liquid Level | 458 | 558 | 658 | 758 | Coil | Bool | 1 | R |
| Alarm Liquid Leak | 459 | 559 | 659 | 759 | Coil | Bool | 1 | R |
| Alarm Over Temp | 460 | 560 | 660 | 760 | Coil | Bool | 1 | R |
| Alarm Thermocouple | 461 | 561 | 661 | 761 | Coil | Bool | 1 | R |
| Alarm Pressure | 463 | 563 | 663 | 763 | Coil | Bool | 1 | R |
| Element Status | 462 | 562 | 662 | 762 | Coil | Bool | 1 | R |

Table 2: Version 2 Modbus Mapping

5 START-UP

5.1 PRE-START INSPECTION

This Trebor DI Water Heater has been thoroughly tested and inspected for proper performance and operation prior to leaving the factory. Additional pre-start inspection can identify any damage or condition change that may have occurred during shipment of the heater and reduce nuisance problems during start-up.

5.1.a Verify Shipping Condition

Refer to Section 3.1, Unpacking.

5.1.b Hazardous Power Terminals

Refer to PM Schedule, Section 4.3.b. Tighten hazardous power connections at the main circuit breaker, distribution circuit breakers, distribution contactors and SSRs. Slightly loose connections at these hazardous power terminals can cause arcing. This arcing can introduce higher than normal operating temperatures, resulting in damage of electrical components. Tighten terminal in a clockwise direction only. Do not loosen terminals before tightening as this may affect the contact area.

5.1.c Electrical Inspection

Refer to system schematic. Visually inspect all electrical components for anything that seems unusual, such as damaged wire insulation, disconnected wires, etc.

5.1.d Plumbing Leak Check

- Refer to PM Schedule, Section 4.3.b. Inspect heater for leaks during start-up. Open the front door and visually watch the leak tray as the system is initially filled with water. Visually inspect heater module fittings and heater system plumbing for leaks.
- If leaks are found at the flare fittings, hand tighten fittings while they are at ambient temperature. Do not use a wrench to tighten flare fittings, as excessive tightening can cause damage to the fittings.

If any problems are encountered during start-up of this heater, contact Trebor for technical support.

5.2 SYSTEM ON

Activate the power to the system by rotating the “Main Breaker” handle to ON. If the display on the control panel does not illuminate, ensure that the EMERGENCY OFF button is in the operate position. Press the reset button to engage control power.

5.3 HEATER MODULE POWER

When the RESET button is pressed, the power contactors will engage.

5.4 PROCESS ALARMS

If a fault occurs, the main contactor will disengage, an indicator LED will turn red to show the type of fault, and an audible alarm will sound. Pressing the RESET button will silence the audible alarm. If the RESET button is pushed and there are no active faults, the heater will restart.

6 SHUT DOWN

The DI water heater may be shut down by the following methods:

- Select the OFF button on the control screen to put the heater in standby (heater element power will be disengaged).
- Rotate “Main Breaker” to off position.
- Turn off the facility supply.
- Lockout and tagout heater for maintenance or repair. Refer to Section 2.5.

7 MAINTENANCE

7.1 REPAIR INSTRUCTIONS

Heater modules have a finite life. Spare heating modules should be on hand in case of a failure.

NOTE: If top element fails then switch off lower element for consistent temperature control.

7.1.a Heater Element Check

If the control screen indicates a check heater element status bar, check the heater diagnostic display for information about heater module status. Visually inspect the main and auxiliary circuit breakers. Then check the corresponding element isolation circuit breaker to see if it has tripped.

Check the continuity of the heating elements as follows:

1. Shut off power to the system.
2. Lockout and Tagout power to heater.
3. Switch off the element circuit breakers in the control enclosure.
4. Check for continuity between the two screw terminals on the left of the breaker for each pair of element circuit breakers.
5. If no continuity exists, replace the suspect heater modules; see Section 7.1.b Heater Replacement.
6. If there is continuity, then the heater element is OK. Refer to the Troubleshooting Section of this manual for other possible causes.

7.1.b Heater Replacement

The heater modules have been designed for quick replacement to minimize downtime and field service requirements. To replace a heater module, follow these procedures:

- Turn power off to system (see Section 2.5 for Lockout/Tagout procedures).
- Drain system (see Section 7.1.e, Draining the System).
- Remove the rear panel of the enclosure to access heater modules.
- Disconnect the electrical connector to the failed module.
- Remove process thermocouple by unthreading thermocouple fitting from top header of the module. It should be hand tight. A wrench may be required to loosen.

- Remove steel band clamps, but do not remove clamps used on modules for connecting the electrical box.
- Loosen fluid inlet and outlet fittings on module.
- Disengage the inlet fitting by sliding the bottom of heater off shelf.
- Lower the heater to disengage top fitting from manifold.
- Use an absorbent cloth to remove any liquid from the leak sensor probe and leak containment well.
- Install replacement heater module into cabinet in reverse order from above. Note: Carefully align the fittings because they can easily be cross-threaded.
- Return failed heater module.

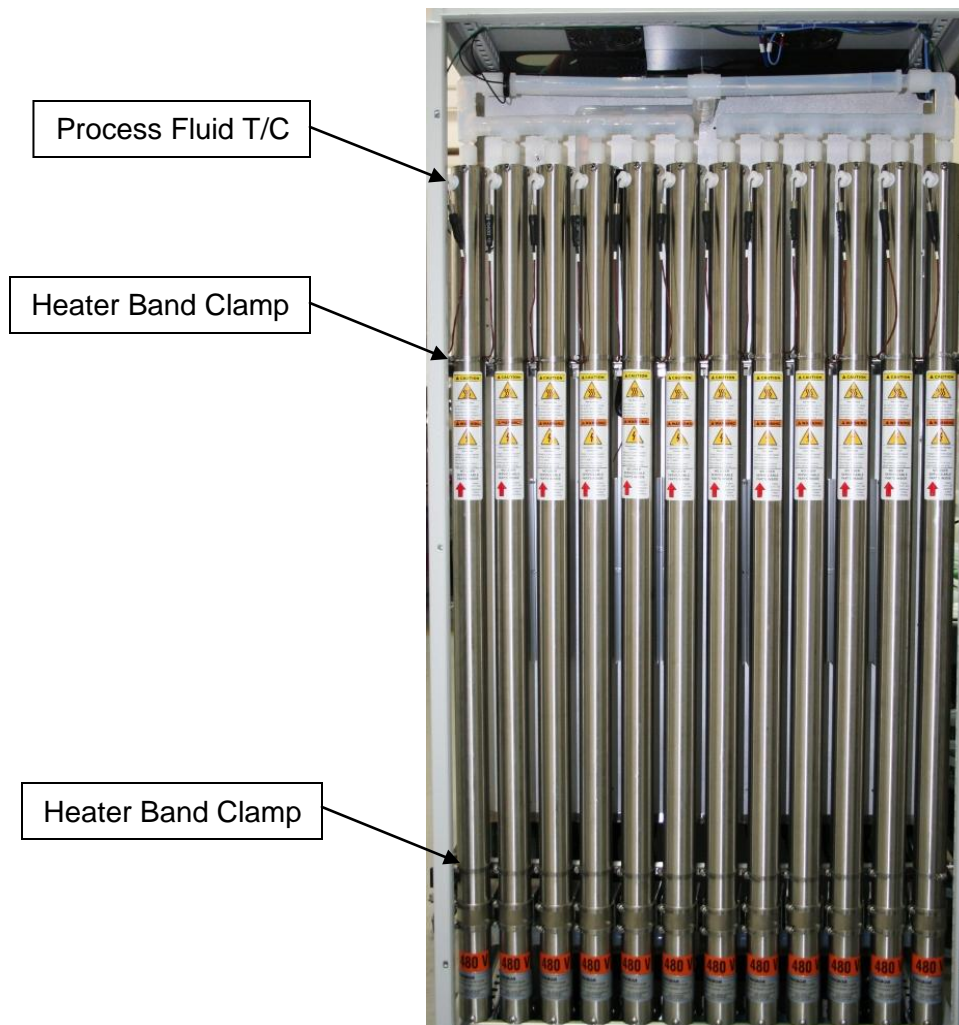

Figure 7-1:

NOTE: Do not disassemble the heater module. There are no user serviceable parts inside the module. If disassembled, any product warranties will be invalid.

7.1.c Liquid Level and Leak Sensor Calibration

- Contact factory for calibration instructions.

7.1.d Fuse Replacement

There are two different ratings of fuses in the electrical control box. See the Appendix and the electrical schematic for fuse locations. All fuses are CCMR type.



CAUTION: Fuses must be replaced with the same type of fuse and rating. Failure to do so could result in a safety hazard and cause injury to personnel and equipment. Consult factory for further information.

7.1.e Draining the System

- Close heater DI water inlet isolation valve.
- Connect fluid inlet to an open drain line. (Alternate: If a drain line is connected to the cabinet drain on the bottom of the heater enclosure, the heater may be drained into the leak tray.)
- Power system and open DI water inlet isolation valve.
- Loosen a fitting in the upper manifold to release internal vacuum in the line.
- The system will drain through the cold DI inlet; a small amount of water will drain through fluid exit port.
- Perform required maintenance.
- Reconnect fluid inlet and outlet to process lines and refill the system.
- Draining the system with out power requires manual activation of the inlet isolation valve by pressing the red button (see Figure 7-2: Isolation Valve).



Figure 7-2: Isolation Valve

7.1.f Leaks

When a leak has been detected it is recommended that the supply water be shut off along with the main circuit breaker. Allow sufficient time for the heater and plumbing to cool down before inspection.

NOTE: If water is leaking out of the heater module shroud a replacement module will be required.

7.1.g Overpressure Relief Replacement

- Turn power off (see Section 2.5).
- Drain system (see Section 7.1.e).
- Remove and replace overpressure relief fitting (note orientation of fitting).
- Refill system.
- Inspect for leaks.
- Turn power on (see Section 5.2 and 2.5).

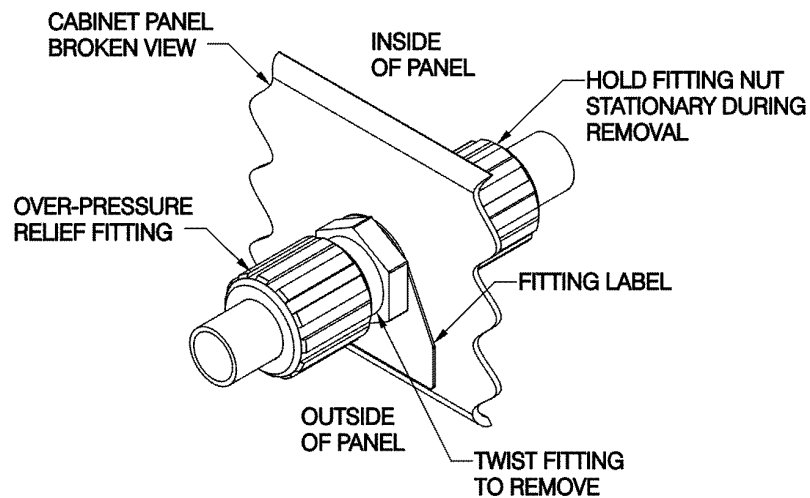

MTD0387

Figure 7-3

7.2 PREVENTIVE MAINTENANCE SCHEDULE

Quantum

| Initial Start | Weekly | 6 Months | Items | Visually Inspect | Tighten |
|---------------|--------|----------|---|------------------|---------|
| X | X | | Process Control / Heater Element Status | X | |
| X | | X | Plumbing Leaks | X | |
| X | X | | Overpressure Relief Drain & Diaphragm | X | |
| X | | X | General Electronics | | X |
| X | | X | Solid State Relays (SSR's) | | X |
| X | | X | Main Circuit Breaker | | X |
| X | | X | Distribution Breakers & Contactors | | X |
| X | | X | Branch Circuit Breakers | | X |

See following table for details on each item.

Verify torque at least every 6 months with a calibrated torque wrench. Do not over tighten. Consult factory with questions.

| Label | Part Number | Description | Torque Value |
|--------------|-------------|---|---------------------|
| MCB1 | - | Circuit Breaker, 3 Pole, 480VAC, 60A - 225A | 30.5 Nm / 270 in-lb |
| MCB1 | - | Connection Terminal Block, 6Wire, 14-6AWG | 6.0 Nm / 53.1 in-lb |
| CB1-4 | 98003862 | Circuit Breaker, 3 Pole, 480VAC, 50A | 5.6 Nm / 49.6 in-lb |
| CONT 1-4 | 98003544 | Contactor, 50A, 400V, 3 Pole, 24VDC | 2.5 Nm / 22.1 in-lb |
| SSR 1-8 | 98004141 | SSR, 125A, 4-32VDC, 48-660V | 3.7 Nm / 32.7 in-lb |
| CBH 1E1-12E2 | 98003865 | Circuit Breaker, 2 Pole, 480VAC, 15A | 2.5 Nm / 22.0 in-lb |
| F1-F4 | 98003253 | Fuse Holder, 600V, 30A, 1 Pole | 1.6 Nm / 14.2 in-lb |
| 24VDC-PS | 98003781 | Power Supply, 10A, 320-575VAC, 3 Phase | 0.6 Nm / 5.3 in-lb |
| TLM 1-2 | 98003897 | 8 Channel Temperature Monitor | 0.4 Nm / 3.1 in-lb |
| | 98003505 | Connection Block, NO, 24VDC | 0.8 Nm / 7.1 in-lb |
| | 98003520 | Connection Block, NC, 24VDC | 0.8 Nm / 7.1 in-lb |

| ITEM | DETAILS |
|--|--|
| Plumbing Leaks | Visually check DI water lines outside of heater cabinet for signs of leaks at the connections. (A leak sensor will detect leaks, but this periodic visual check is recommended.) Also, visually check bottom of cabinet inside heater module enclosure for DI water leaks. Tighten fitting(s) if necessary. If heater module is leaking, contact Trebor for instructions. |
| Overpressure Relief Drain & Diaphragm | Visually check the drain line for water running from the heater. The overpressure burst fitting can start leaking if the system has experienced pressures above 60 PSIG. The burst fitting can be checked by inspecting the relief port at the back of the cabinet. No water should be present in the relief drain since it is required to be plumbed to an open drain. If water is present in the drain plumbing, the fitting should be replaced. |
| General Electronics | Visually check electronics inside control enclosure for any signs of overheating, deformation, or corrosion. |
| Solid State Relays | The SSR's should be free of corrosion at the terminals and should not have signs of overheating or deformation. The wires attached to the SSR's should be clean and in good condition. Check and tighten mounting screws for optimum heat transfer to heatsink. |
| Main Circuit Breaker | The main circuit breaker should be checked for signs of loose connections at the termination lugs. Damaged lugs should be replaced. The terminals should be checked for tightness. |
| Distribution Breakers & Contactors | The distribution breakers and contactors should be checked for signs of loose connections at termination lugs. Damaged lugs should be replaced. The terminals should be checked for tightness. |
| Branch Circuit Breakers | These should be checked for signs of loose connections at the termination lugs. The terminals should be checked for tightness. |

8 TROUBLESHOOTING

Display is Not Illuminated

Cause:

- EMO button engaged.
- No power at main circuit breaker.
- Control fuse is blown.
- Main breaker is OFF.

Solution:

- Twist EMO in direction of arrows (see Section 2.3).
- Review wiring procedure (see Section 3, Installation).
- Replace fuse.
- Main breaker to ON.

Alarm Sounds

Cause:

- DI supply pressure.
- Liquid level.
- Leak sensor.
- Thermocouple damaged.
- Plugged orifice in heater.
- Over-temperature alarm.

Solution:

- Check water supply pressure at source.
- Check water supply at source.
- Check overpressure relief diaphragm.
- Verify flow is on.
- Check manifold and heater modules for leak. Visually inspect leak tray.
- If fault repeats, check thermocouple leads to OTC for continuity. Check T/C plugs in top heater modules.
- Check fluid lines in and out of manifold for flow.
- Check if heater element has failed and replace module (see section 7.1).
- If fault reports, check T/C leads to OTC for continuity.
- Verify fan operation.

Check Heater Element Status Alert

Cause:

- Failed heater.
- Circuit breaker tripped.
- Heater enable.

- Solid State Relay (SSR) may have "frozen" open or closed.

Solution:

- Check if heater element has failed and replace module (see Section 7.1).
- Check and reset the main, auxiliary and element isolation circuit breakers.
- Consult Trebor if circuit breaker repeatedly trips.

- An SSR has failed in the open mode: Shut system off immediately and replace the failed SSR. SSR's should be replaced in pairs.

9 WARRANTY

See the Trebor Standard Limited Warranty at
<http://www.treborintl.com/TechnicalSupport.aspx>