

# ***INLINE DI HEATER***

---

## ***Operation / Maintenance Manual***

# CONTENTS

<b>1</b>	<b>INTRODUCTION.....</b>	<b>3</b>
1.1	INTENDED USE AND AUDIENCE.....	4
1.2	HEATER PERFORMANCE .....	4
<b>2</b>	<b>SAFETY .....</b>	<b>5</b>
2.1	SAFETY PRECAUTIONS.....	5
2.1.a	General Safety.....	5
2.2	SAFETY MESSAGE CONVENTIONS .....	5
2.2.a	Caution .....	5
2.2.b	Warning .....	6
2.2.c	Danger.....	6
2.3	HEATER INTERLOCKS .....	6
2.3.a	Leak Sensor.....	6
2.3.b	Element Over-Temperature Protection .....	6
2.3.c	Liquid Over-Temperature Protection .....	7
2.3.d	Internal Over-Temperature Protection.....	7
2.3.e	Liquid Level Sensor Interlock .....	7
<b>3</b>	<b>INSTALLATION.....</b>	<b>8</b>
3.1	UTILITY REQUIREMENTS .....	9
3.2	UNPACKING .....	9
3.3	ORIENTATION.....	9
3.4	FLUID CONNECTIONS.....	9
3.4.a	Inlet & Outlet.....	9
3.5	ELECTRICAL CONNECTIONS.....	9
<b>4</b>	<b>OPERATION.....</b>	<b>10</b>
4.1	GENERAL.....	10
4.2	LIQUID START-UP.....	10
4.3	TEMPERATURE CONTROL.....	11
4.4	SHUT DOWN.....	11
<b>5</b>	<b>MAINTENANCE.....</b>	<b>13</b>
5.1	SPARE PARTS.....	13
5.2	PREVENTIVE MAINTENANCE SCHEDULE .....	13
5.3	REMOVAL AND REPLACEMENT INSTRUCTIONS .....	13
5.3.a	Heater Replacement.....	13
5.3.b	Heater Decommissioning .....	13
5.3.c	Heater Disposal .....	13
<b>6</b>	<b>TROUBLESHOOTING.....</b>	<b>14</b>
6.1	IRREGULAR TEMPERATURE CONTROL.....	14
6.2	HEATER ELEMENT CHECK .....	14
6.3	INTERLOCK SENSORS .....	15
<b>7</b>	<b>WIRING SCHEMATIC .....</b>	<b>16</b>
<b>8</b>	<b>OPTIONS.....</b>	<b>18</b>
8.1	FLUID CONNECTIONS (IDH18V400DF06B01): .....	18
8.2	INTERLOCK TEMPERATURE SENSORS (IDH18V400DF06B01):.....	18
8.3	OUTLET TC FITTINGS (IDH18V400DF06B01):.....	18
<b>9</b>	<b>WARRANTY AND EXCLUSIONS.....</b>	<b>19</b>
<b>10</b>	<b>CONTACT INFORMATION .....</b>	<b>20</b>
10.1	GENERAL CONTACT INFORMATION.....	20
10.2	TECHNICAL SUPPORT .....	20
10.3	REGIONAL REPRESENTATIVES .....	20

# 1 INTRODUCTION

## Inline Deionized Water Heater (IDH)

Trebor's inline deionized water heater provides ultra-high purity and reliability.

The flow path is smooth, free of particle traps and constructed entirely of GE 214 quartz and PFA, making it capable of the purest of applications. The design prevents metal ion contamination if the external thin-film heating element should fail.

Trebor's patented sealing technology protects against liquid leaks and eliminates a common failure associated with fragile quartz fluid connections breaking. In addition, there are no O-rings to service or replace.

The IDH consists of multiple heating elements in a single housing. Each element can be controlled individually or collectively.

### Features

- Quartz/PFA/PTFE liquid path
- PFA weld-able fluid fittings
- No metal contamination risk
- No particle traps
- Efficient heat transfer and small thermal mass for fast response
- SEMI S2 and CE compliant

### Performance Summary

IDH	Value
Voltage	400V~
Power	18kW
Max Current Draw	28A
Maximum Pressure	0.55 MPa
Maximum Water Temperature	100 °C
Minimum Pressure	0.10 MPa
Minimum Flow Rate (series)	2 LPM
Minimum Flow Rate (parallel)	6 LPM
Environmental Temperature	5-40°C
Environmental Humidity	Max 80%
Max Altitude	2,000m



Shown with optional 3/8" Flare TC fittings on outlet side.

## 1.1 INTENDED USE AND AUDIENCE

The IDH is designed to safely heat DI water. The IDH is not intended for use with combustible or flammable chemistries, such as solvents, or chemistries, such as HF or KOH, with accelerated quartz etch rates.

This manual covers the Trebor IDH and heater accessories provided by Trebor. The user is responsible for the external control system and all necessary connections required to safely operate the heater (see Sections 4.3 and 7)

The Trebor IDH is not to be used for proposes other than that which is designed for. The heater and optional components are to be used only with liquids and parameters stated within this manual. This manual assumes personnel are familiar with the installation, operation and maintenance requirements of water heaters.

The IDH is intended for use by properly trained personnel. Read and understand this manual prior to installation and/or operation of the heater. Do not use this equipment until familiar with its operation and safety features.

## 1.2 HEATER PERFORMANCE

Figure 1-1 shows an approximate change in water temperature per pass.

Trebor recommends limiting continual operation at 80% full power as well as a minimum of 2 LPM when plumbed in series, and 6 LPM when plumbed in parallel.

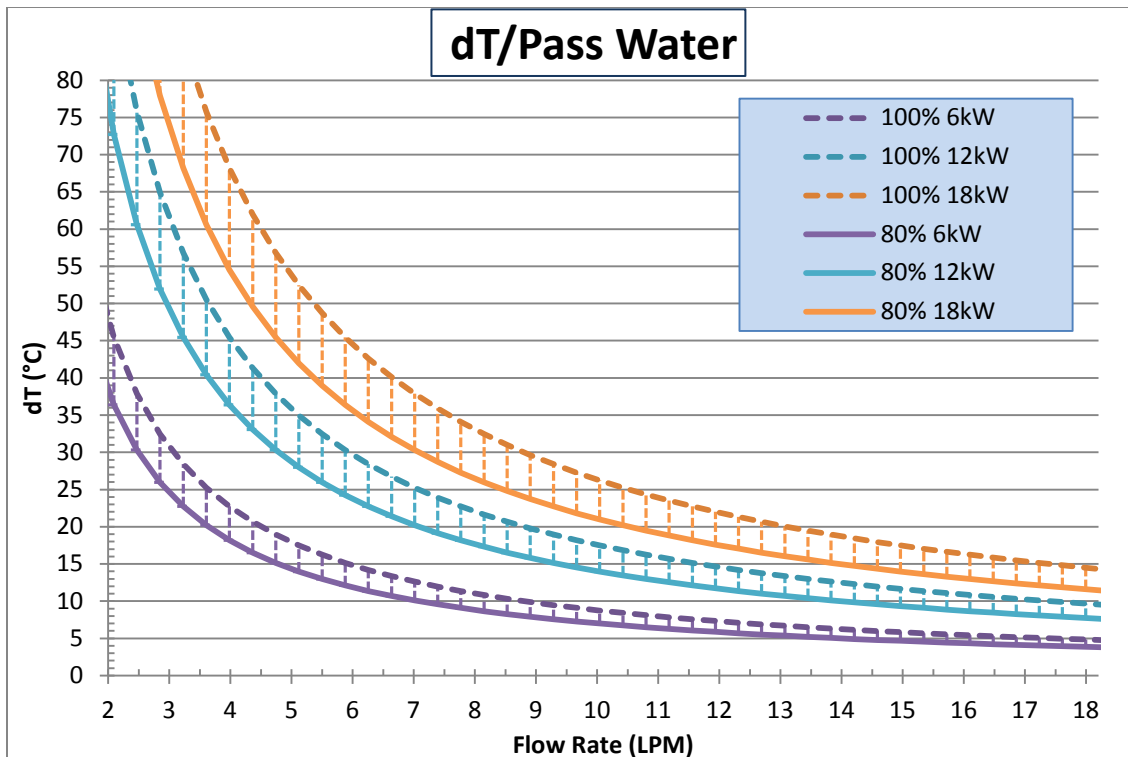

Figure 1-1: Approximate Temperature Change in Water per Pass

## 2 SAFETY

---

### 2.1 SAFETY PRECAUTIONS

This section provides important information for safe operation of the IDH.

The equipment described in this manual uses hazardous voltage electricity that can be dangerous. Local policies and procedures for safely operating any Trebor chemical heater(s) supersede the safety considerations listed below. It is the responsibility of all personnel to follow such policies and procedures. All safety guard devices must be in place when equipment is in operation. Operators, set-up operators, helpers or installation personnel should not alter, remove or disable safety devices or equipment.

If the inline heater is used in a manner other than stated in this operation manual, the protection provided by the heater may be impaired.

#### 2.1.a General Safety

- There are no serviceable parts inside the heater assembly; never open or disassemble. Attempting to do so will void the product warranty.
- Do not attempt to service electrical equipment without proper safety training and certification or without an understanding of first aid for electrical shock and hazardous fluid spills.
- Lockout and tag the electrical and fluid systems prior to installation or replacement. Refer to your company safety policies and procedures prior to installation or replacement.
- Always disengage the heater and optional equipment from electrical and fluid sources prior to installation or replacement.
- Always refer to your company safety policies and procedures for flushing and decontamination prior to removal.

### 2.2 SAFETY MESSAGE CONVENTIONS

#### 2.2.a Caution

A **Caution** message indicates a potentially hazardous situation, which, if not avoided, could result in minor or moderate injury. It may also be used to alert against unsafe practices. A typical **Caution** message:

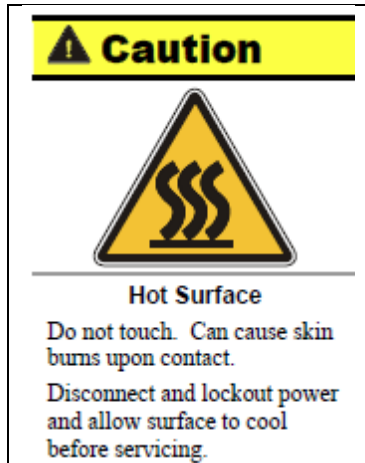

**2.2.b Warning**

A Warning message indicates a potentially hazardous situation that, if not avoided, could result in serious injury. A typical example of a **Warning** message:

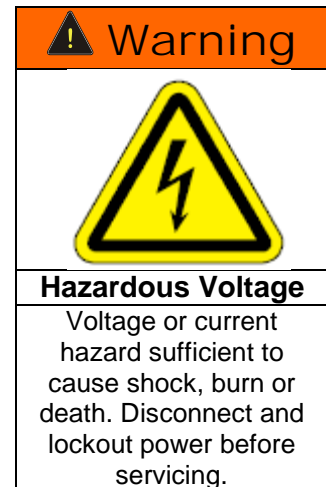

**2.2.c Danger**

A Danger message indicates an imminently hazardous situation that, if not avoided, will result in death or serious injury. Messages identified by the word **Danger** are used sparingly and only for those situations presenting the most serious hazards

**2.3 HEATER INTERLOCKS**

**2.3.a Leak Sensor**

The Trebor IDH is supplied with a 24Vdc conductive liquid leak sensor. Refer to leak sensor manufacturer for further details. See Section 7 for wiring instructions.

**2.3.b Element Over-Temperature Protection**

The Trebor IDH is supplied with a temperature sensor(s) located on the heater element. The element temperature sensor(s) must be used with an interlock to ensure the element temperature does not exceed 250°C. See Section 7 for wiring instructions.

### **2.3.c Liquid Over-Temperature Protection**

The maximum liquid temperature ( $T_{\max}$  °C) can be estimated from the element temperature ( $T_e$  °C), heater power rating (P - i.e. 3-kW, 4-kW, 6-kW, etc.) and duty cycle (duty %).  $T_e = T_{\max} + P * \text{duty} * 16.1$

**Example 1:** Given a maximum allowable liquid temperature of 100°C, a heater rated at 6 kW and a 100% duty cycle, the maximum element temperature limit is:

$$T_e = 100^\circ\text{C} + (6) * (1.00) * (16.1)$$

$$T_e = 196.6^\circ\text{C} \text{ (Maximum allowable element temperature)}$$

**Example 2:** Given a maximum allowable liquid temperature of 100°C, a heater rated at 6 kW and a 75% duty cycle, the maximum element temperature limit is:

$$T_e = 100^\circ\text{C} + (6) * (0.75) * (16.1)$$

$$T_e = 172.5^\circ\text{C} \text{ (Maximum allowable element temperature)}$$

### **2.3.d Internal Over-Temperature Protection**

The Trebor IDH is supplied with a temperature sensor(s) located near the top of the quartz substrate. The control system must limit the quartz substrate temperature interlock sensor to a maximum temperature of 200°C. See Section 7 for wiring instructions.

### **2.3.e Liquid Level Sensor Interlock**

The Trebor IDH requires a liquid level interlock with a sensor located at the heater outlet to prevent dry operation. This level sensor is not supplied and should be controlled by the user.

### 3 INSTALLATION

Ensure that all heater interlock and safety devices are functional prior to operation (refer to Section 2, Safety Requirements). Before starting the system, it is important to read and understand Section 4, Operation. Only trained, qualified, authorized personnel should operate this heater.

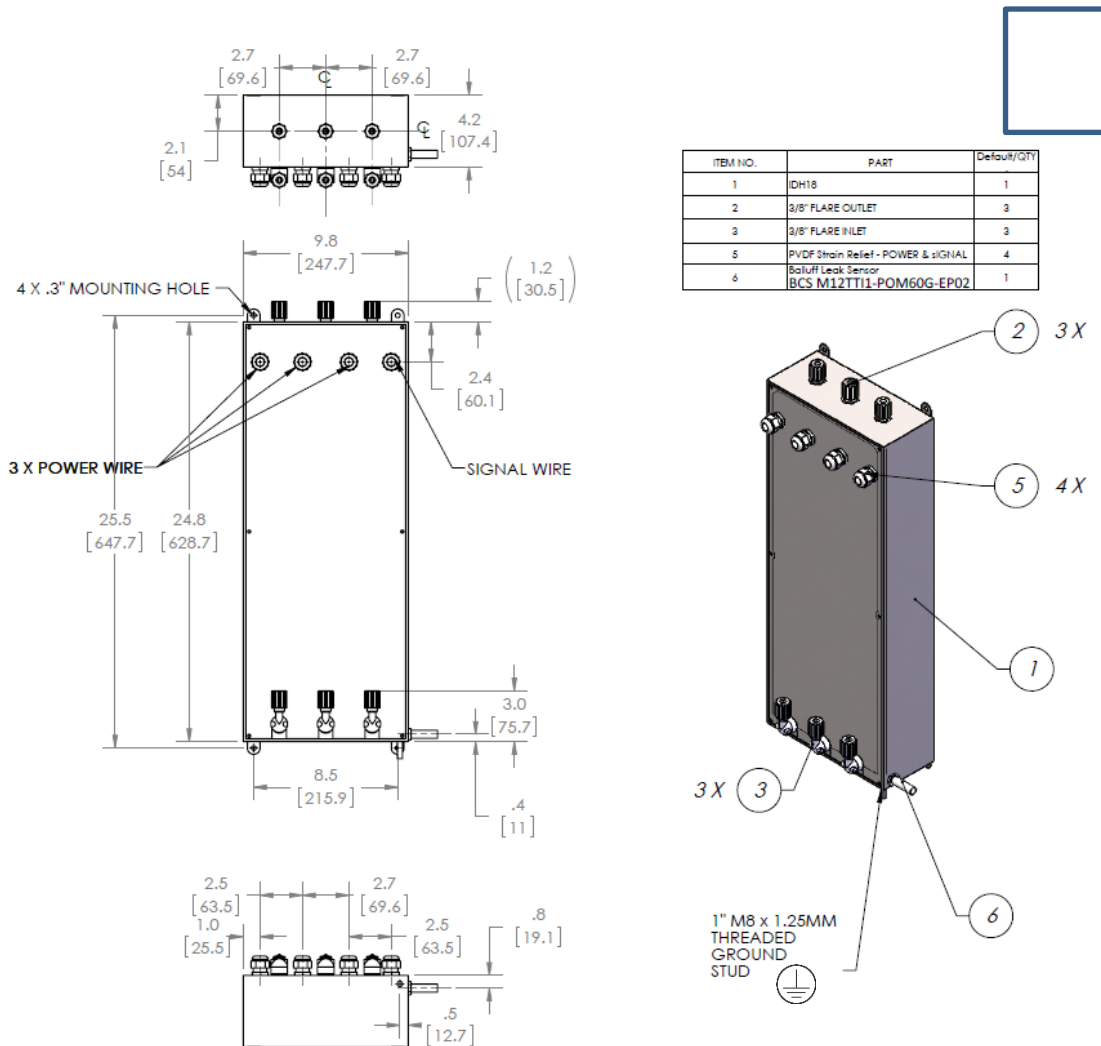

**Figure 3-1**

Use 1/4" or equivalent bolts to mount heater to ≥ 1/2" thick UHMW or equivalent structural wall.



### 3.1 UTILITY REQUIREMENTS

<u>Utility</u>	<u>Inline DI Heater</u>
<b>System Power:</b>	<ul style="list-style-type: none"> <li>• 3ea - 6kW 400 Vac 50/60 Hz, 3Ø, 30 Amp Service</li> </ul>
<b>Maximum Pressure</b>	<ul style="list-style-type: none"> <li>• 0.55 MPa (80 psig)</li> </ul>
<b>Heater Weight:</b> (Approximate)	<ul style="list-style-type: none"> <li>• 11kg (24.25lbs)</li> </ul>

### 3.2 UNPACKING

The system should be checked for any damage that may have occurred during shipment. Damage should be reported to the carrier immediately.

The following items should be contained within the shipping container:

<u>QTY.</u>	<u>DESCRIPTION</u>
1	Inline DI Heater / Optional Accessories
1	Operation / Maintenance Manual

### 3.3 ORIENTATION

The heater must be positioned within 15° of vertical. Horizontal mounting will reduce heater life and void warranty. The heater should be installed so that the weight of the heater is either supported by the heater mounting bracket or other system that prevents the support of the heater on the plumbing.

### 3.4 FLUID CONNECTIONS

#### 3.4.a Inlet & Outlet

- Attach the inlet and outlet fluid connections following the fitting manufacturer's procedures. Fluid connections are located at the bottom (inlet) and top (outlet) of the heater, see Figure 3-1.
- Verify flow direction.
- Trebor recommends repeating at least 2 thermal cycles with DI water to check for leaks before putting the unit into service.

### 3.5 ELECTRICAL CONNECTIONS

Connection of required electrical hook-ups is required between the heater and control system. See Section 7 for wiring instructions.

## 4 OPERATION

### 4.1 GENERAL

Ensure that all heater interlock and safety devices are functional prior to operation (refer to Section 2, Safety Requirements).

The IDH is designed to heat Deionized Water in either single pass (trim) or recirculation applications up to 100°C. Figure 4-1 shows approximate flow capacity versus temperature rise per fluid pass.

Minimum Flow Rate: 2 LPM (0.53 gpm)

Minimum Pressure: 0.10 MPa (15 psig)

**⚠ WARNING:** Element temperatures capable of heating beyond to 250°C. Safety precautions should be taken (refer to Section 2, Safety Requirements).

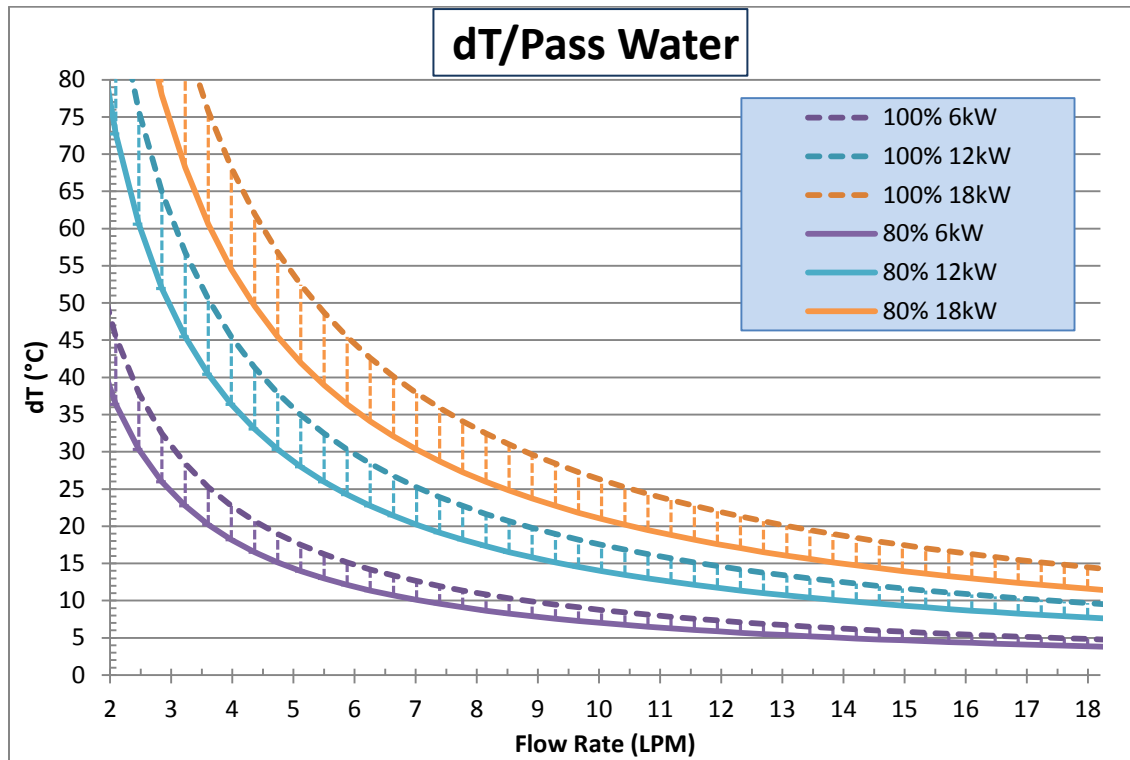

Figure 4-1

### 4.2 LIQUID START-UP

- Ensure that plumbing is secure.
- Turn "On" the liquid supply.
- Check for leaks in the system plumbing.
- Allow the liquid to run through the system approximately 2 minutes prior to energizing the heater.

### 4.3 TEMPERATURE CONTROL

An external control system is required for operating the IDH; see Figure 4-2 for a typical control set up. The system should consist of:

- temperature control system, interlock controls (see Section 2.3), and
- outlet liquid temperature sensor(s).

Operating settings and parameters are to be determined by the user.

The control scheme should be set up to not only control the liquid outlet temperature but also limit the heater element surface temperature to a maximum of 250° C (see Section 2.3.b).

The control system should supply a pulse width with a period less than 1 second to prevent element damage.

The main Circuit breaker must be in close proximity to the equipment and within easy reach of the operator. It also must be marked as the disconnecting device for the heater. The circuit breaker should be sized according to the breaker manufacturer's specification (generally this is max current draw +25%) and the heater size shown in Sec. 3.1.

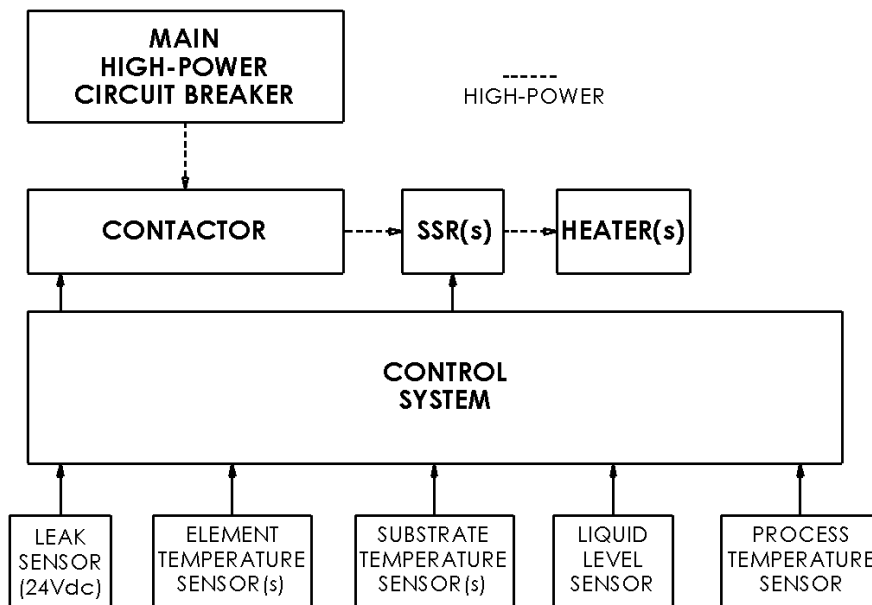

Figure 4-2

### 4.4 SHUT DOWN

The following procedure should be used to safely shut down the heater:

- Cut-off power to the heater.
- Allow liquid to pass through the heater for at least 5 minutes or until the outlet temperature drops below 50°C.

Note: The user is responsible for providing an EMO circuit to interlock their entire system. This device can also be used to disengage heater power.

---

## 5 MAINTENANCE

---

### 5.1 SPARE PARTS

Description	PN	QTY
FTG;PFA;FLR;3/8Tx3/8RFx3/8RF;TEE	98004242	2
SENSOR;LEAK;PTFE;CAPACITIVE;24VDC;PNP	98004261	1

### 5.2 PREVENTIVE MAINTENANCE SCHEDULE

The IDH requires no preventive maintenance.

### 5.3 REMOVAL AND REPLACEMENT INSTRUCTIONS

#### 5.3.a Heater Replacement

The IDH has been designed for quick replacement to minimize downtime and field service requirements. To replace a heater, use the following procedures:

- Shut down per Section 4.4.
- Turn power off to system (electrical and liquid).
- Flush and/or decontaminate per your company policy.
- Disconnect the electrical connection and interlocks to the heater.
- Drain liquid from the heater (if present).
- Disconnect the fluid inlet/outlet connections.
- Remove heater assembly.
- Install replacement heater per Section 3.
- Start-up per Section 4.2.
- Contact Trebor or a factory authorized representative for return procedures, if required.

#### 5.3.b Heater Decommissioning

Heater assemblies removed from service, decommissioned, or dismantled should follow the steps outlines in Section 5.3.a for removing the heater assembly.

#### 5.3.c Heater Disposal

Heater assemblies being disposed are to be disposed of per your company policy.

## 6 TROUBLESHOOTING

The following is an outline of routine troubleshooting techniques. For conditions not covered in this section consult Trebor or a factory authorized representative.

### 6.1 IRREGULAR TEMPERATURE CONTROL

SYMPTOM	CAUSES	SOLUTIONS
Poor Temperature Control	Low liquid flow Location of outlet temperature sensor Incorrect control settings	Increase flow Relocate outlet temperature sensor closer to heater outlet Adjust control settings or scheme
Heater Does Not Heat	Failed heater Wiring short Interlock alarm Control system error	Check heater element per Section 6.2 Check heater wiring Address system alarms Evaluate controller

### 6.2 HEATER ELEMENT CHECK

Lockout and Tagout power to the heater. Disconnect the heater power electrical connections and measure the resistance between power wires or to the neutral wire. Resistance should be less than the values listed in Table 6-1.

Heater Power	Power Wire to Power Wire	Power Wire to Neutral Wire
6-kW, 3Ø	<52Ω	N/A

**Table 6-1: Element Resistance Check**

### 6.3 INTERLOCK SENSORS

ALARM	CAUSES	SOLUTIONS
Liquid Leak	Liquid leak detected inside heater housing Sensor/wiring shorted or improperly wired to interlock	If liquid is present in the housing, decommission and replace heater per Section 5.3 Inspect/test sensor wiring
Element Over-Temperature	No liquid or insufficient flow through the heater Insufficient control settings or scheme Sensor/wiring shorted or improperly wired to interlock	Increase flow rate Modify control settings or scheme to limit the element to $\leq 250^{\circ}\text{C}$ Inspect/test sensor wiring
Liquid Over-Temperature	Insufficient flow through the heater Insufficient control algorithm Sensor/wiring shorted or improperly wired to interlock	Increase flow rate Check for blockage Relocate outlet temperature sensor closer to heater outlet Adjust control settings or scheme Inspect/test sensor wiring
Liquid Level	Insufficient liquid present in heater Liquid boiling Sensor/wiring shorted or improperly wired to interlock	Increase flow rate Review liquid properties vs. conditions Adjust sensor Inspect/test sensor wiring

## 7 WIRING SCHEMATIC

- Heater Power Wiring (IDH18V400DF06B01):

<b>3Ø Power (Option D)</b>	
<b>Wire Color</b>	<b>Description</b>
Black	Power
Black	Power
Black	Power
White	Not Used
Green\Yellow	Ground

- Heater OTC Signal Wiring (IDH18V400DF06B01):

<b>PT1000 RTD</b>	
<b>Wire Color</b>	<b>Description</b>
Blue & Purple	Element #1
Brown & White/Brown	Element #2
Gray & White/Gray	Element #3
Yellow & White/Yellow	Substrate #1
Orange & White/Orange	Substrate #2
Green & White	Substrate #3

- Heater Internal Leak Wiring (IDH18V400DF06B01):

<b>PNP, Normally Closed</b>	
<b>Wire Color</b>	<b>Description</b>
Brown (BN)	+ 24 VDC Supply
Black (BK)	Signal
Blue (BU)	0 VDC Common

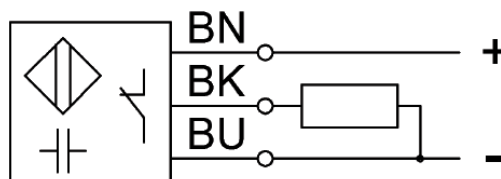



• Heater Wiring Schematic:

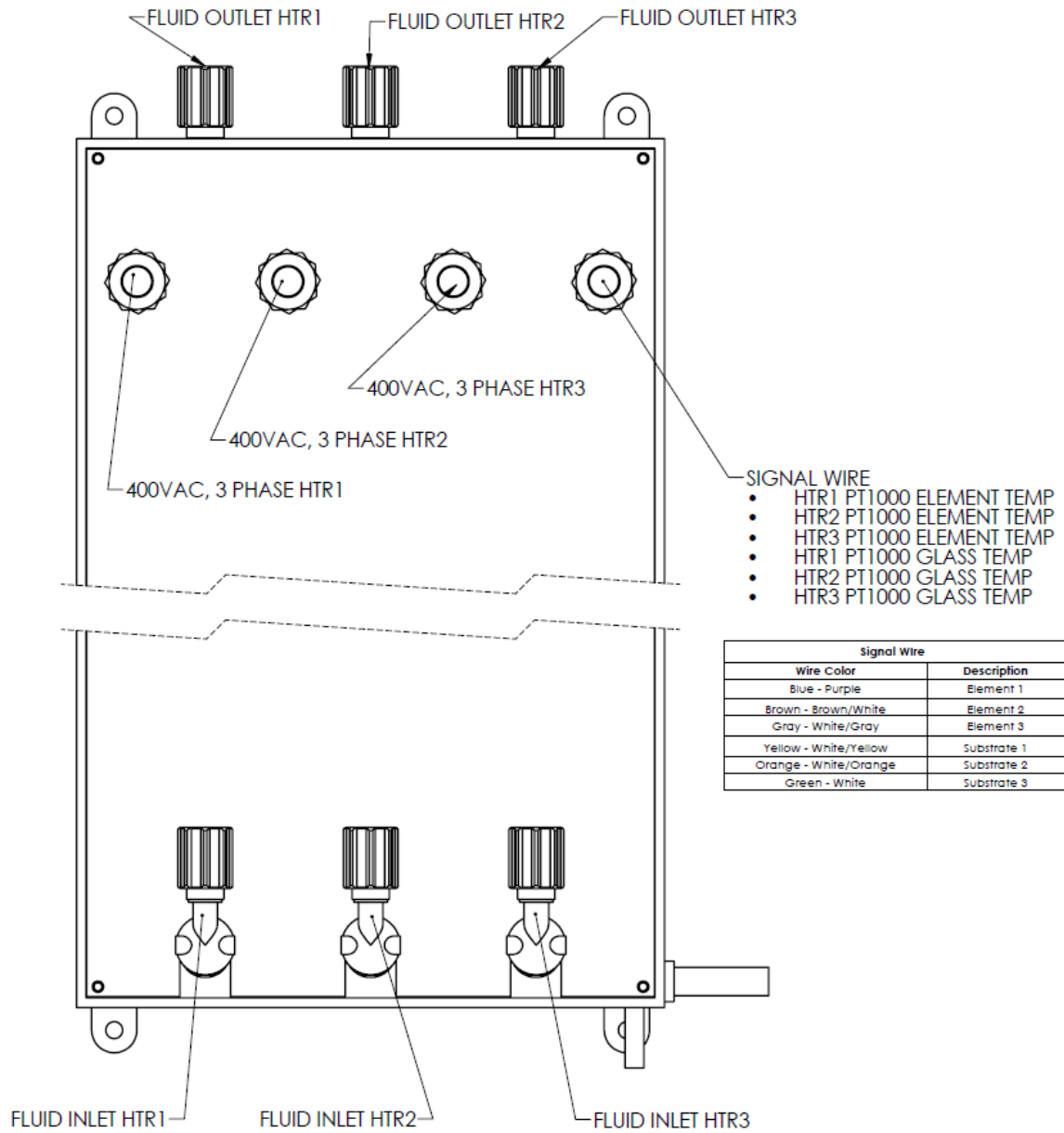

Figure 7-1

## **8 OPTIONS**

---

### **8.1 FLUID CONNECTIONS (IDH18V400DF06B01):**

- 3/8" PFA Flare (Option F06 – Standard)

### **8.2 INTERLOCK TEMPERATURE SENSORS (IDH18V400DF06B01):**

- PT1000 RTD (Option B – Standard 3Ø)

### **8.3 OUTLET TC FITTINGS (IDH18V400DF06B01):**

- 3/8" PFA Tee Fitting, male/male/female (Option 01)

## **9 WARRANTY AND EXCLUSIONS**

---

See the Trebor Standard Limited Warranty at

<http://www.treborintl.com/sites/treborintl.com/files/content/TreborStandardLimitedWarranty.pdf>

## 10 CONTACT INFORMATION

---

### 10.1 GENERAL CONTACT INFORMATION

Web: [www.treborintl.com](http://www.treborintl.com)

Phone Number: (801) 561-0303  
Toll Free Number: (800) 669-1303  
Fax Number: (801) 255-2312

Email: [treborinfo@idexcorp.com](mailto:treborinfo@idexcorp.com)  
[treborsales@idexcorp.com](mailto:treborsales@idexcorp.com)

Address: Trebor International  
8100 South 1300 West  
West Jordan, Utah 84088 U.S.A.

### 10.2 TECHNICAL SUPPORT

Email: [treborservice@idexcorp.com](mailto:treborservice@idexcorp.com)

Phone Number: (801) 244-6156

### 10.3 REGIONAL REPRESENTATIVES

Web: [www.treborintl.com](http://www.treborintl.com)